

SYNEGO[®]
TECHNISCHE INFORMATION
PROFILDRUCK

Inhaltsverzeichnis

Blendrahmen AD	2
Pfosten-Kämpfer AD	4
Blendrahmen MD	6
Pfosten-Kämpfer MD	12
Ausgleichsprofile	14
Flügel	16
Flügelsprossen.	24
Profile für mehrflügelige Fenster ohne festen Pfosten	26
Zubehör für mechanische Verbindungen	31
Bodenschwelle und Zubehör.	36
Zubehör auswärts öffnende Elemente	41
Zubehör für Haus- und Nebeneingangstüren	42
Bohrlehren.	43
Armierungen	45
Artikelverzeichnis	56
Zeichenerklärung	61
Variantensystematik	62

Blendrahmen AD

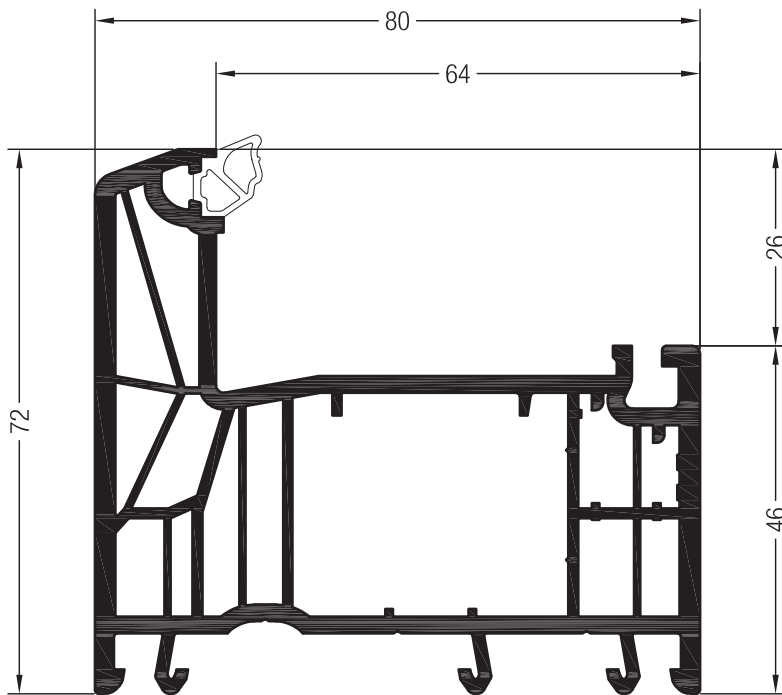

Blendrahmen 72 AD PULS SYNEGO®

1537605

1567605

@

24

Blendrahmen 72 AD PULS SYNEGO®

für Alu-Vorsatzschale

1537608

24

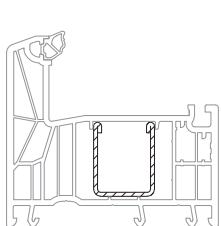
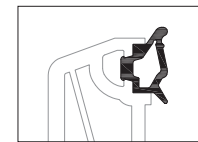

23 x 28

	1306619
	1,5
lx	1,1
ly	1,1
	6

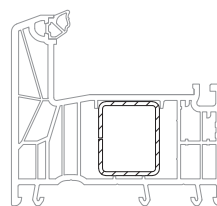

23 x 28

	1357540
	1,5
lx	1,1
ly	1,5
	6

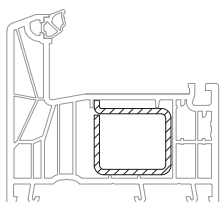

29 x 28

	1357550
	2
lx	2,3
ly	1,8
	6

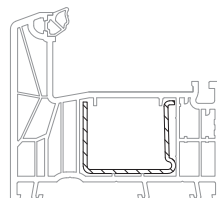

35 x 28

	1244506
	1,5
lx	2,5
ly	1,1
	6

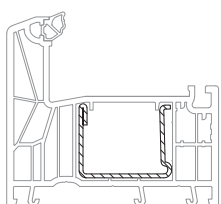

35 x 28

	1244516	1244526
	1,5	2
lx	2,7	3,5
ly	1,3	1,7
	6	6

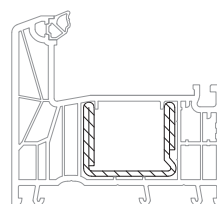

35 x 28

	1244536
	2
lx	5
ly	2
	6

Blendrahmen AD

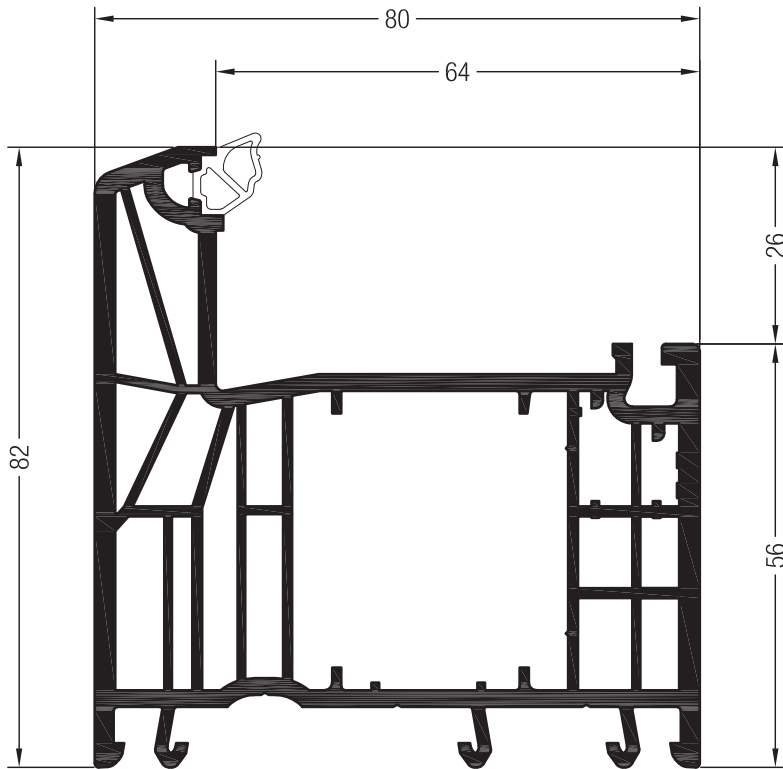

Blendrahmen 82 AD PULS SYNEGO®

1537615

1567615 @

24

Blendrahmen 82 AD PULS SYNEGO®
für Alu-Vorsatzschale

1537618

24

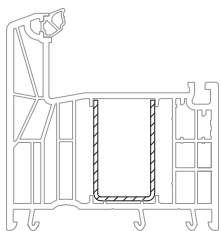
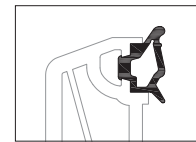

23 x 38

	1357541
	1,5
lx	1,4
ly	2,1
	6

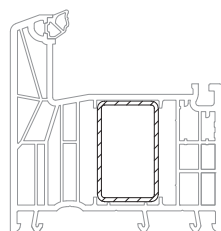

23 x 38

	1357542
	1,5
lx	1,5
ly	3,2
	6

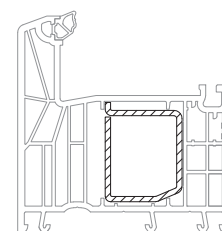

29 x 37,5

	1357559
	2
lx	2,9
ly	3,9
	6

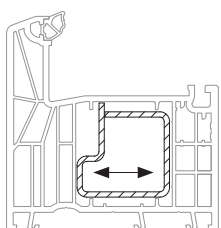

35 x 36

	1357543
	2
lx	3,6
ly	3,7
	6

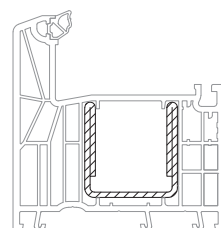

35 x 36

	1357608
	2
lx	6,6
ly	3,9
	6

Pfosten-Kämpfer AD

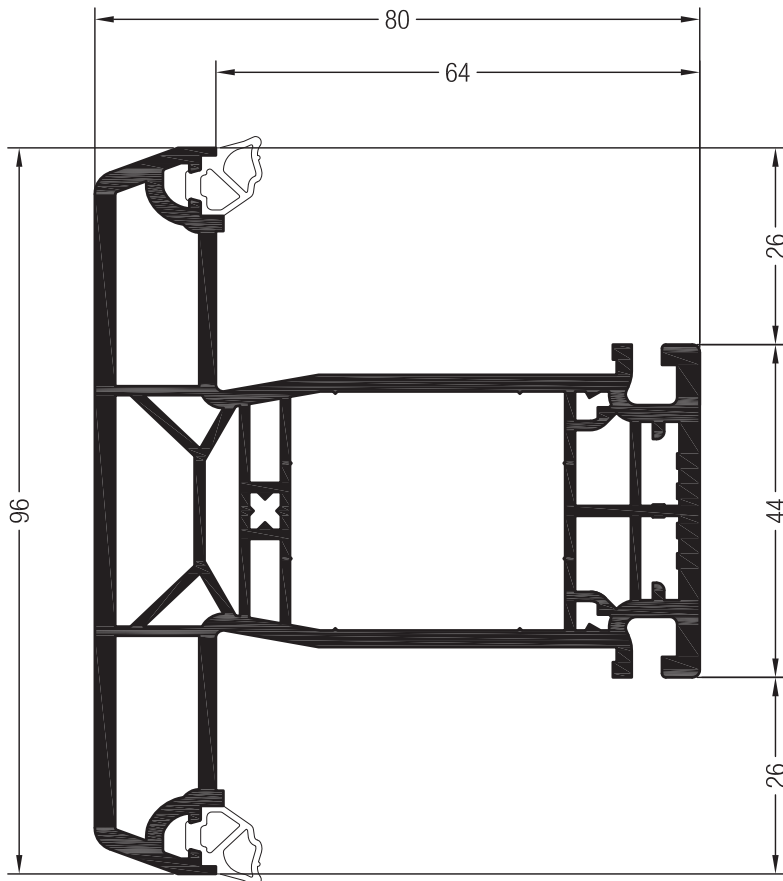

Pfosten 96 AD PULS SYNEGO®

1537405

1567405

24

Pfosten 96 AD PULS SYNEGO®
für Alu-Vorsatzschale

1537408

24

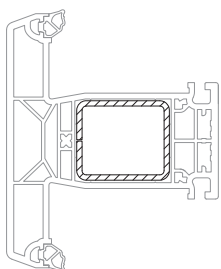
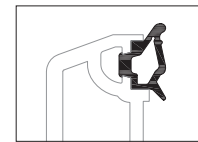

35 x 30

	1357666	1357544
	1,5	2
lx	3,2	4
ly	2,5	3,1
	6	6

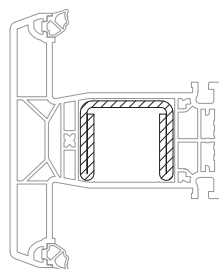

35 x 30

	1357551
	2,5
lx	6,6
ly	2,9
	6

Pfosten-Kämpfer AD

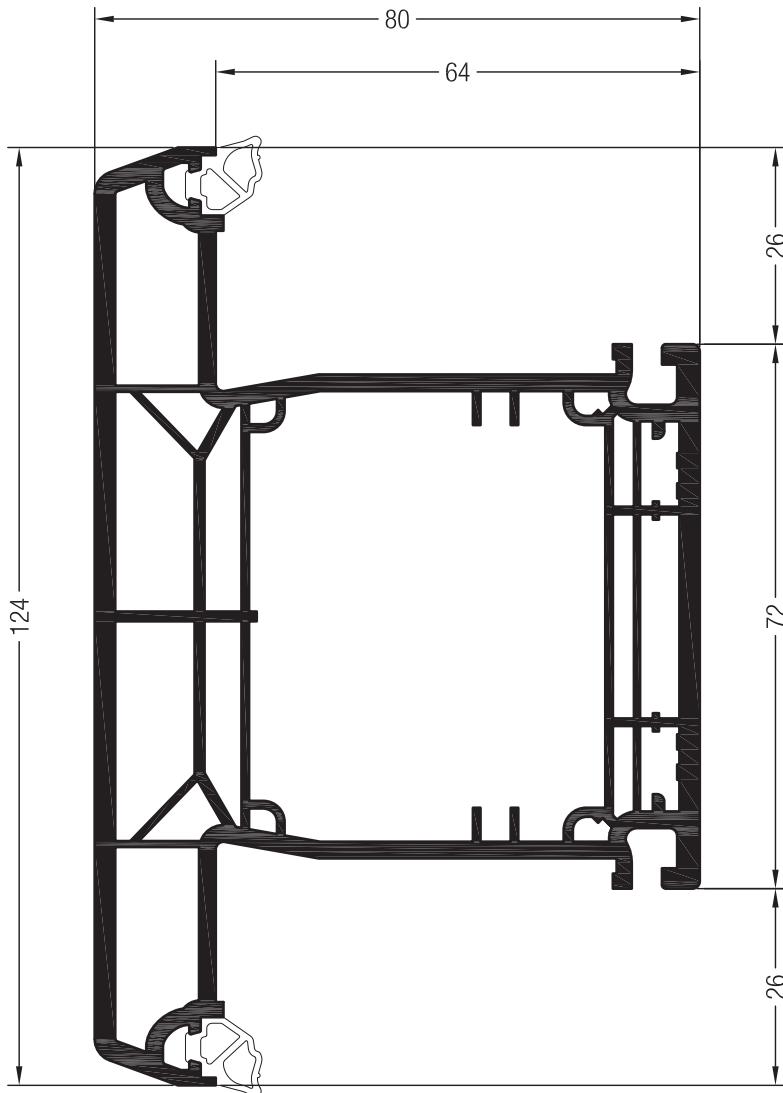

Pfosten 124 AD SYNEGO®

1537415   



1567415  

  @

 12

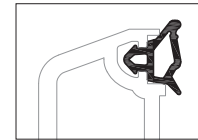



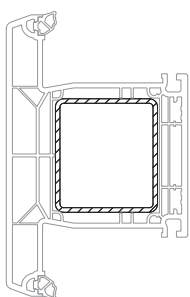

	1357451
	1357451



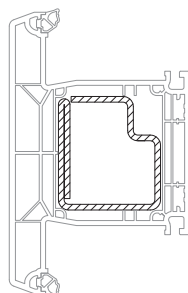

45 x 50

	1357545
	2
lx	11,1
ly	13,1
	6



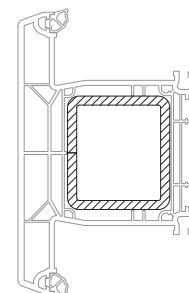

45 x 50

	1357546
	2,5
lx	14,1
ly	15,4
	6



45 x 50

	1357553
	4
lx	19,3
ly	22,8
	6

Blendrahmen MD

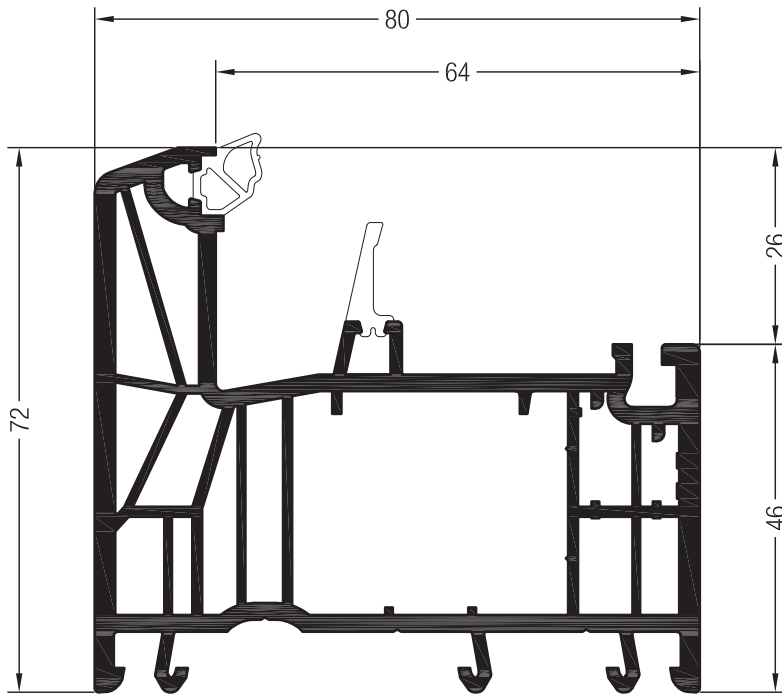

Blendrahmen 72 MD PULS SYNEGO®

1537625

1567625

@

24

Blendrahmen 72 MD PULS SYNEGO®

für Alu-Vorsatzschale

1537628

24

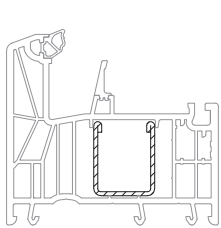
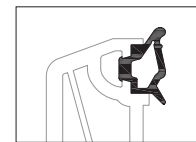

23 x 28

	1306619
	1,5
lx	1,1
ly	1,1
	6

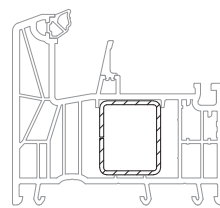

23 x 28

	1357540
	1,5
lx	1,1
ly	1,5
	6

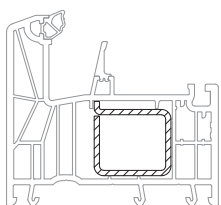

29 x 28

	1357550
	2
lx	2,3
ly	1,8
	6

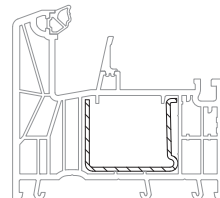

35 x 28

	1244506
	1,5
lx	2,5
ly	1,1
	6

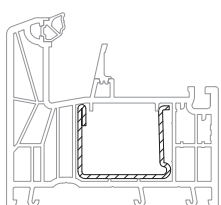

35 x 28

	1244516	1244526
	1,5	2
lx	2,7	3,5
ly	1,3	1,7
	6	6

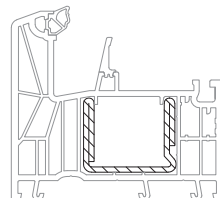

35 x 28

	1244536
	2
lx	5
ly	2
	6

Blendrahmen MD

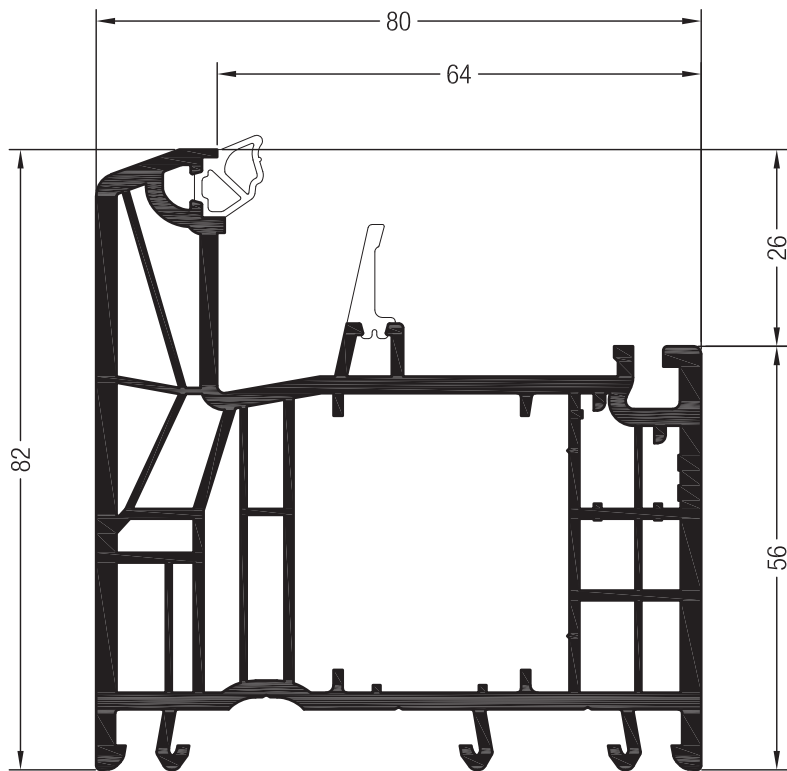

Blendrahmen 82 MD PULS SYNEGO®

1537635

1567635 @

24

Blendrahmen 82 MD PULS SYNEGO®
für Alu-Vorsatzschale

1537638

24

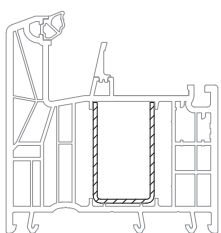
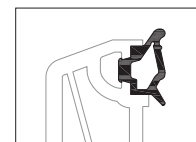

23 x 38

	1357541
	1,5
lx	1,4
ly	2,1
	6

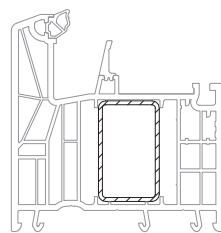

23 x 38

	1357542
	1,5
lx	1,5
ly	3,2
	6

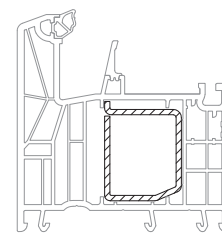

29 x 37,5

	1357559
	2
lx	2,9
ly	3,9
	6

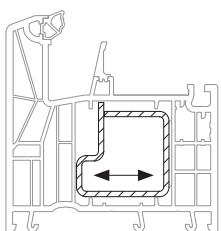

35 x 36

	1357543
	2
lx	3,6
ly	3,7
	6

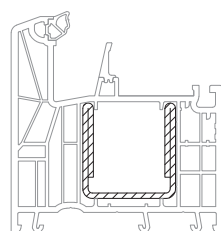

35 x 36

	1357608
	2
lx	6,6
ly	3,9
	6

Blendrahmen MD

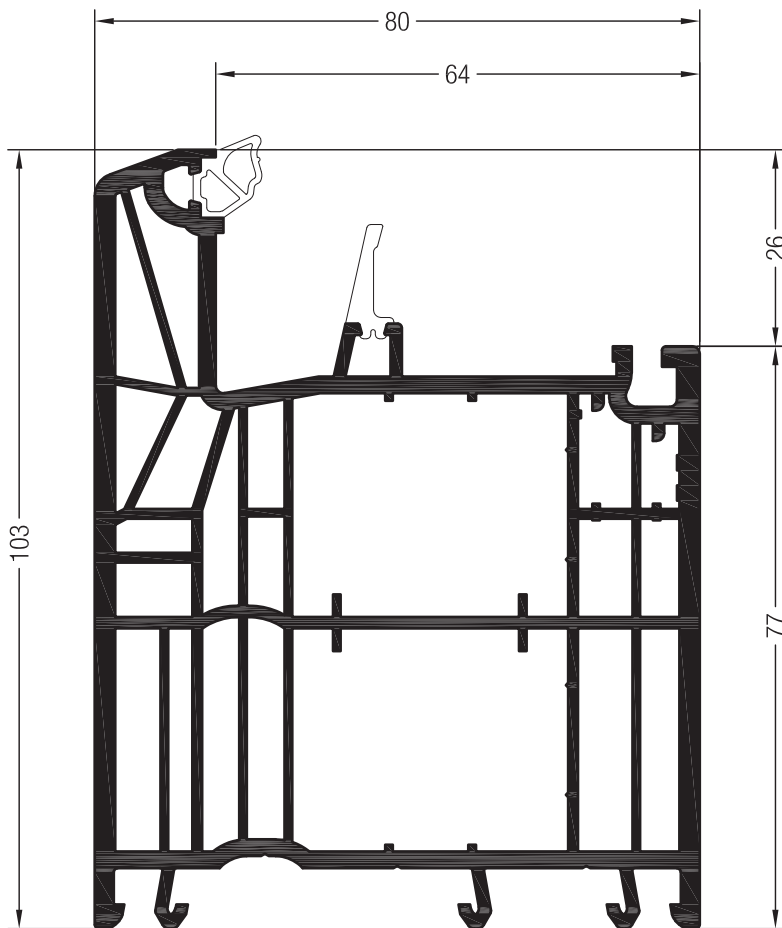

Blendrahmen 103 MD PULS SYNEGO®

1537645

1567645

12

Blendrahmen 103 MD PULS SYNEGO®

für Alu-Vorsatzschale

1537648

12

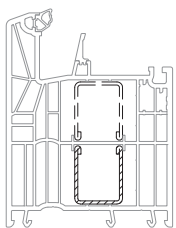
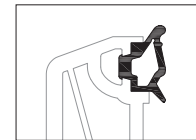

23 x 28

	1306619
	1,5
lx	1,1
ly	1,1
	6

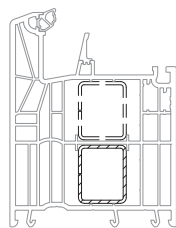

23 x 28

	1357540
	1,5
lx	1,1
ly	1,5
	6

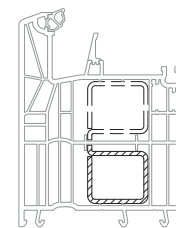

29 x 28

	1357550
	2
lx	2,3
ly	1,8
	6

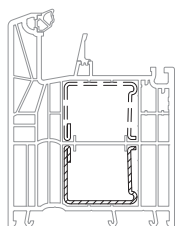

35 x 28

	1244506
	1,5
lx	2,5
ly	1,1
	6

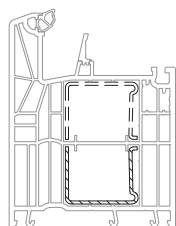

35 x 28

	1244516	1244526
	1,5	2
lx	2,7	3,5
ly	1,3	1,7
	6	6

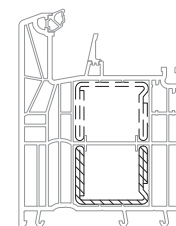



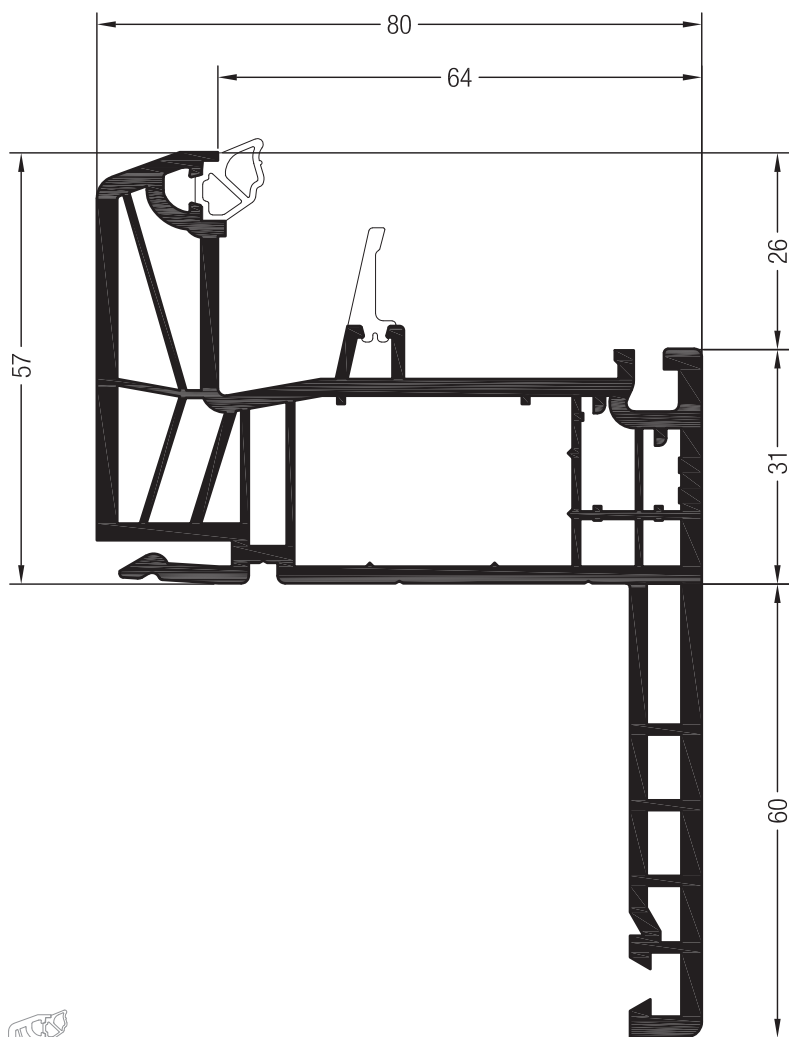

35 x 28

	1244536
	2
lx	5
ly	2
	6

Blendrahmen MD



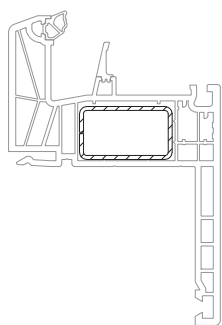

Altbaublendrahmen 57/60 MD SYNEGO®

- 1537665   
-    @
- 1567665    @
-  24



35 x 20

	1239583
	1,5
lx	2,3
ly	0,98
	6

Blendrahmen MD

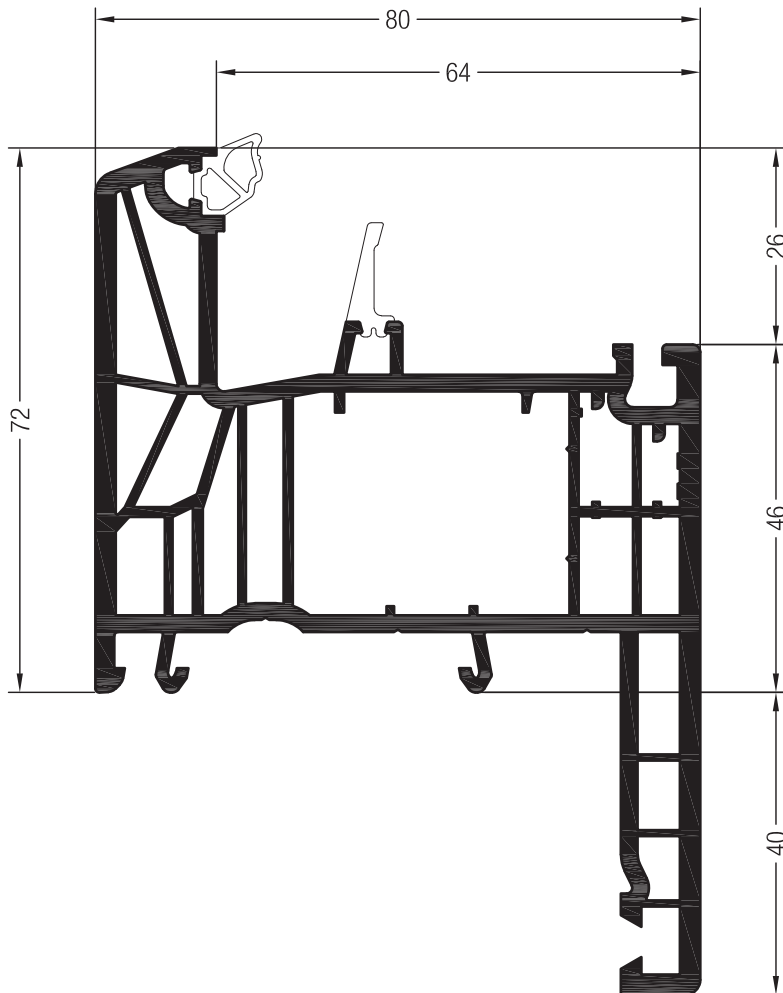

Blendrahmen 72/40 MD PULS SYNEGO®

- 1537195
- @
-
- @
- 1567195 @
- 24

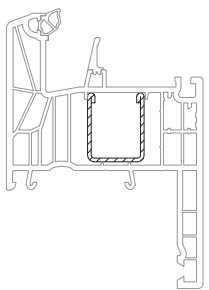

23 x 28

	1306619
	1,5
lx	1,1
ly	1,1
	6

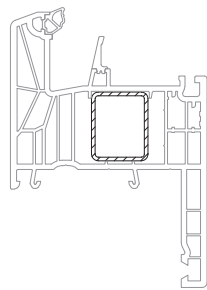

23 x 28

	1357540
	1,5
lx	1,1
ly	1,5
	6

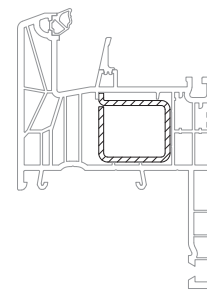

35 x 25

	1357550
	2
lx	2,3
ly	1,8
	6

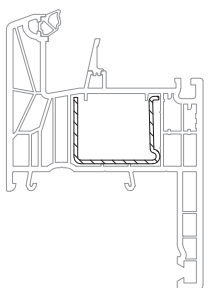

35 x 28

	1244506
	1,5
lx	2,5
ly	1,1
	6

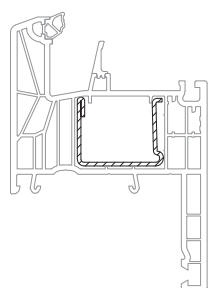

35 x 28

	1244516	1244526
	1,5	2
lx	2,7	3,5
ly	1,3	1,7
	6	6

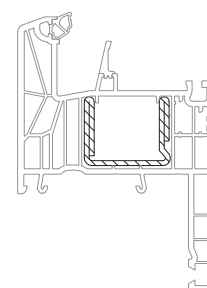

35 x 28

	1244536
	2
lx	5
ly	2
	6

Blendrahmen MD

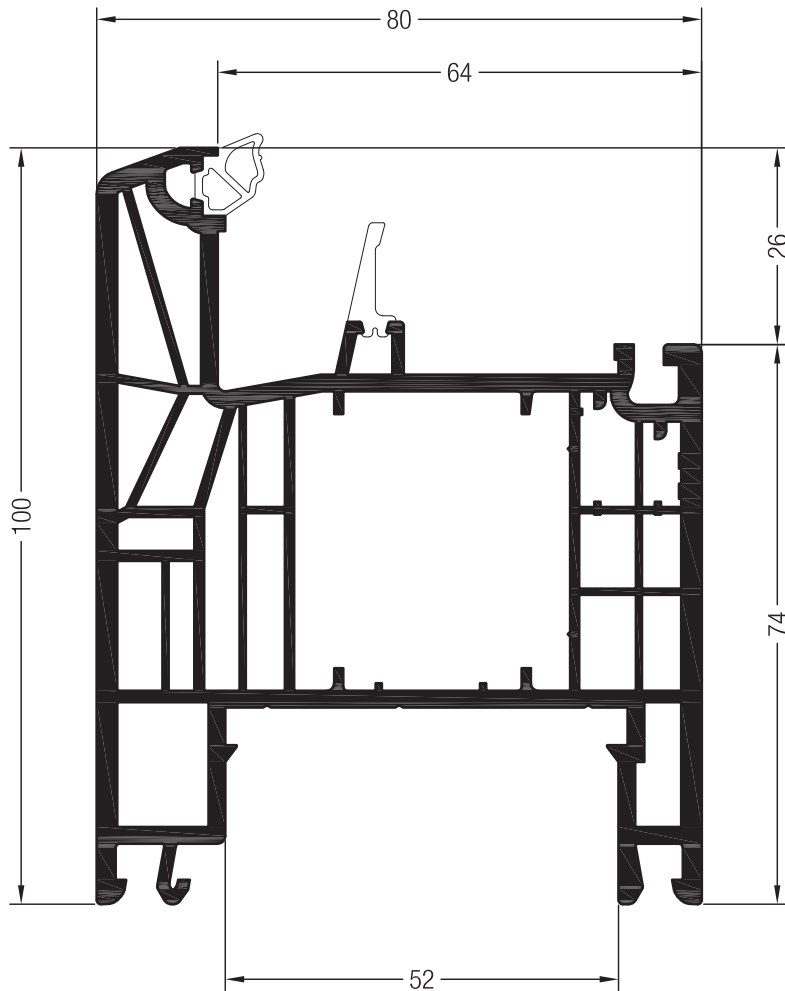

Blendrahmen 100 MD SYNEGO®

- 1537655
- 1567655 @
- 12

Blendrahmen 100 MD SYNEGO®
für Alu-Vorsatzschale

- 1537658 @
- 12

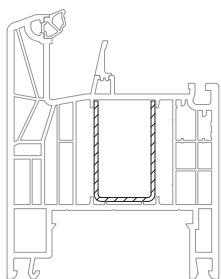
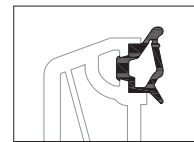

23 x 38

	1357541
	1,5
lx	1,4
ly	2,1
	6

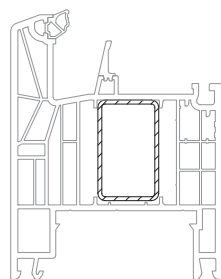

23 x 38

	1357542
	1,5
lx	1,5
ly	3,2
	6

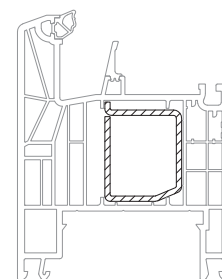

29 x 37,5

	1357559
	2
lx	2,9
ly	3,9
	6

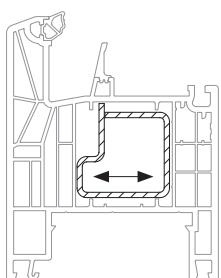

35 x 36

	1357543
	2
lx	3,6
ly	3,7
	6

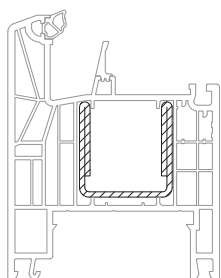

35 x 36

	1357608
	2
lx	6,6
ly	3,9
	6

Pfosten-Kämpfer MD

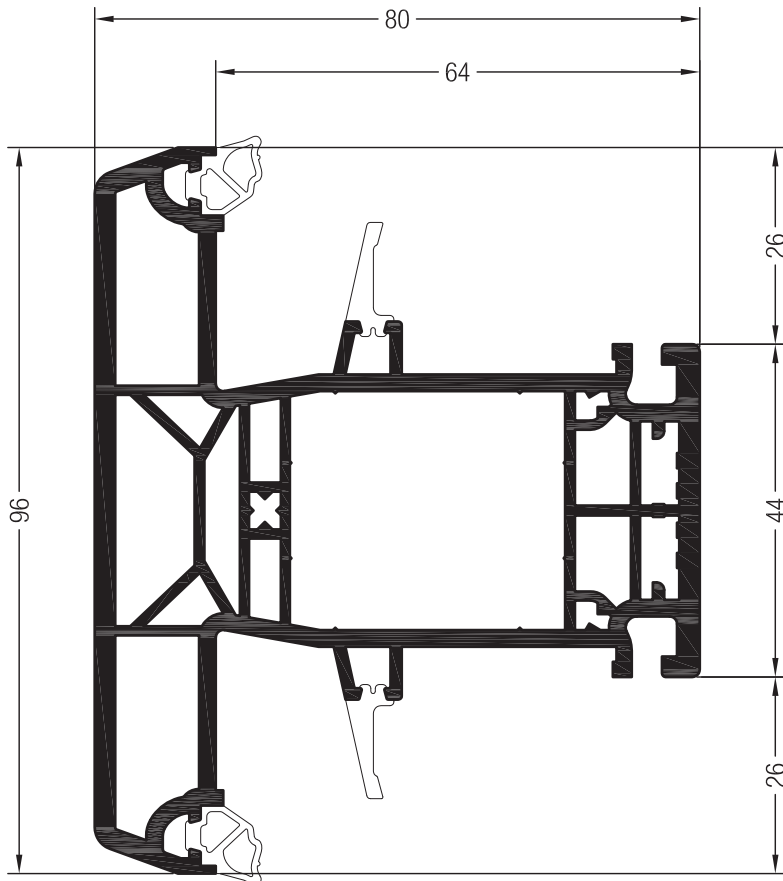

Pfosten 96 MD PULS SYNEGO®

1537505 

1567505   

  @

 24

Pfosten 96 MD PULS SYNEGO®



für Alu-Vorsatzschale

1537508 

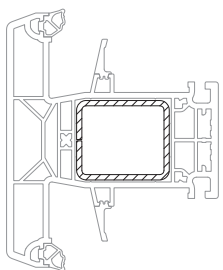
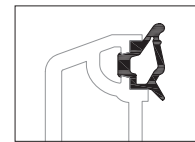
 24



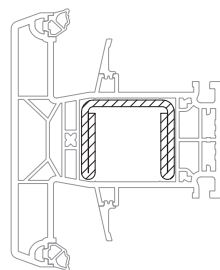

35 x 30

	1357666	1357544
	1,5	2
lx	3,2	4
ly	2,5	3,1
	6	6



35 x 30

	1357551
	2,5
lx	6,6
ly	2,9
	6

Pfosten-Kämpfer MD

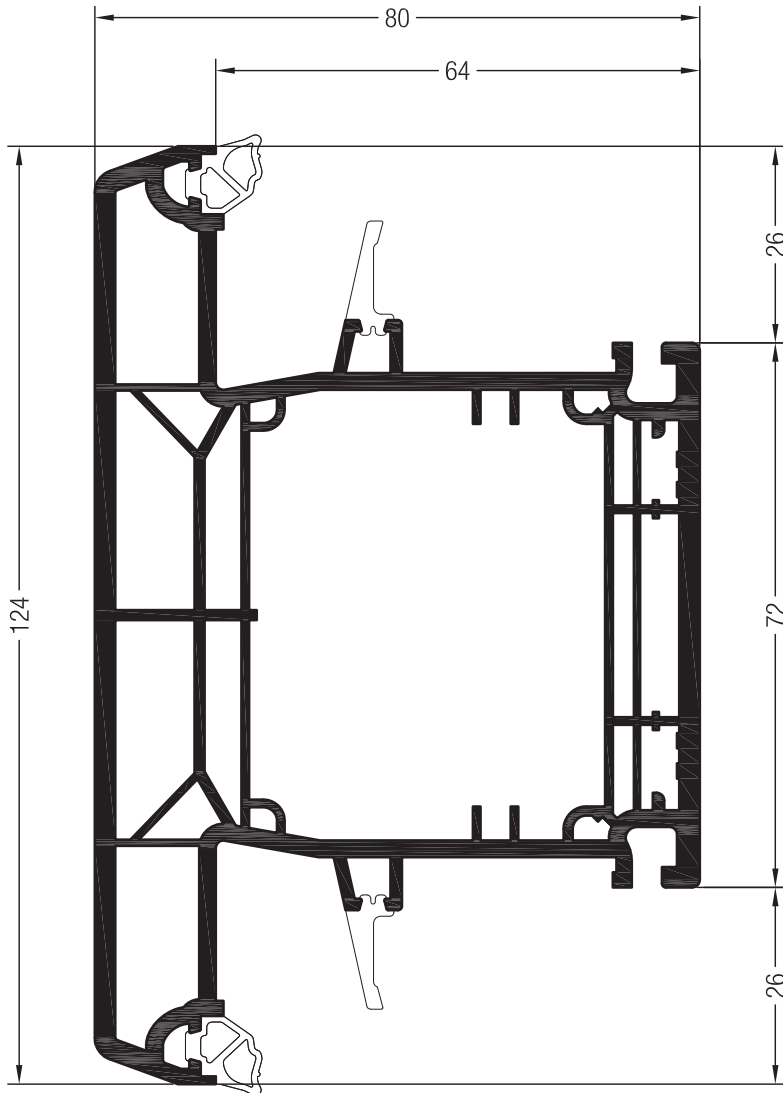

Pfosten 124 MD SYNEGO®

1537515

1567515

@

12

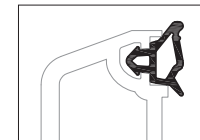

E

	1357451
	1357451

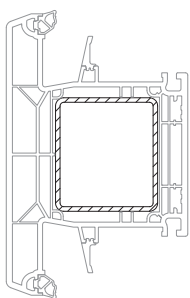

45 x 50

	1357545
	2
lx	11,1
ly	13,1
	6

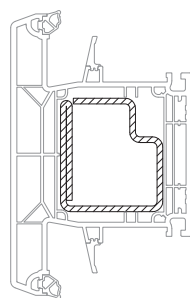

45 x 50

	1357546
	2,5
lx	14,1
ly	15,4
	6

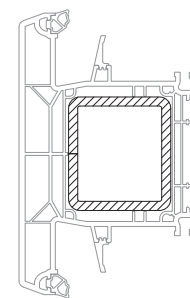

45 x 50

	1357553
	4
lx	19,3
ly	22,8
	6

Ausgleichsprofile

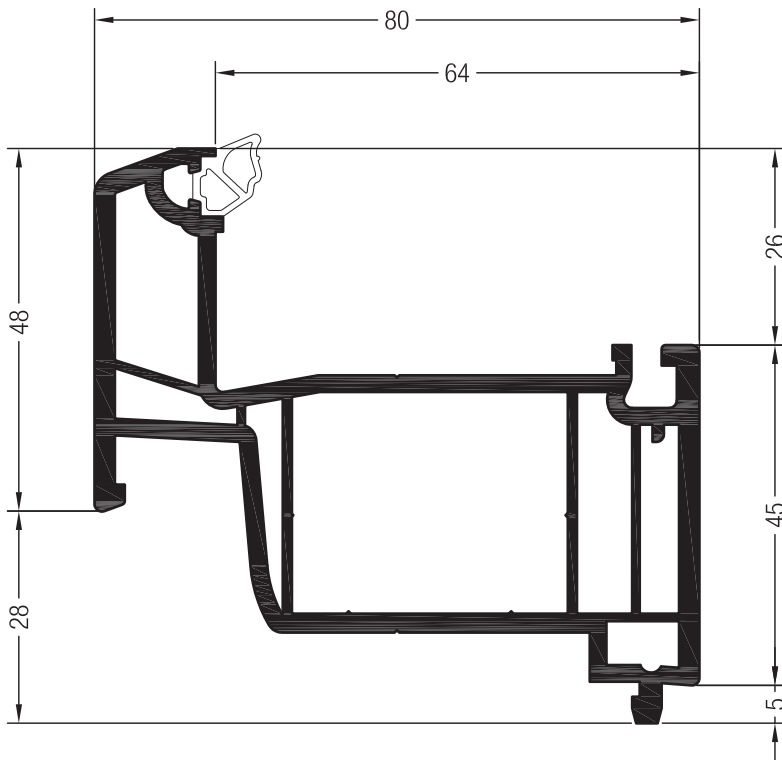

Ausgleichsprofil 48 SYNEGO®
(in Verbindung mit Flügel 59)

1537335

1567335 @

12

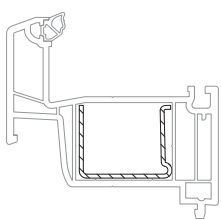

35 x 28

	1244506
	1,5
lx	2,5
ly	1,1
	6

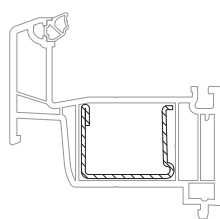

35 x 28

	1244516	1244526
	1,5	2
lx	2,7	3,5
ly	1,3	1,7
	6	6

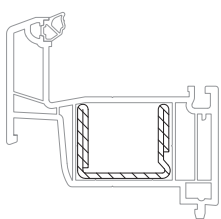

35 x 28

	1244536
	2
lx	5
ly	2
	6

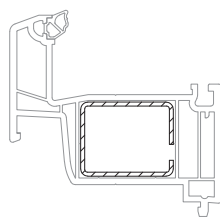

35 x 28

	1237091
	1,5
lx	2,8
ly	2,1
	6

Ausgleichsprofile

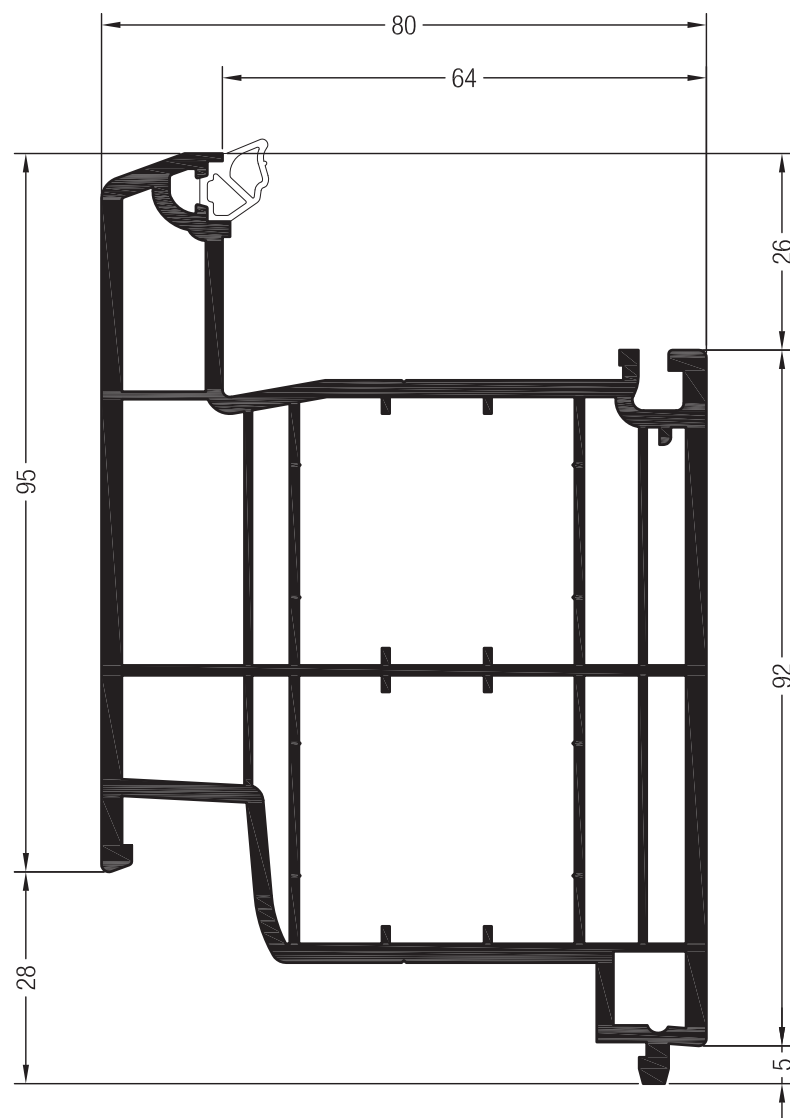

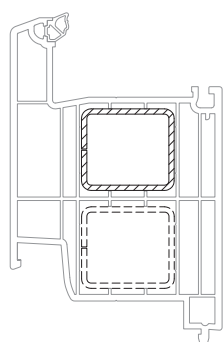

Ausgleichsprofil 95 SYNEGO®
(in Verbindung mit Haustürflügel)

- 1537325   
- 1567325    @
-  12



35 x 30

	1357544
	2
lx	4
ly	3,1
	6

Flügel

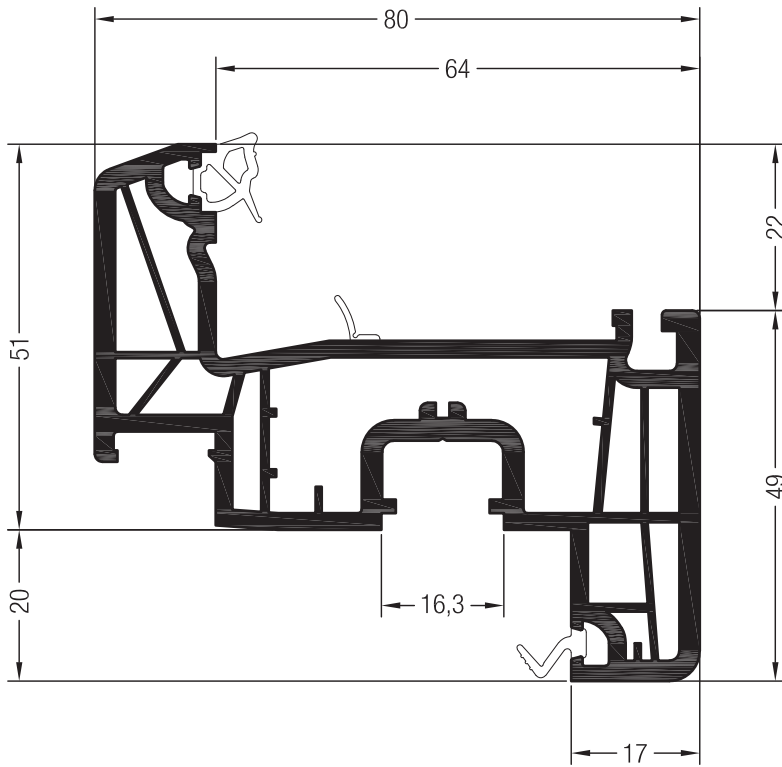

Flügel Z51 SYNEGO®

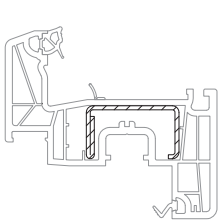
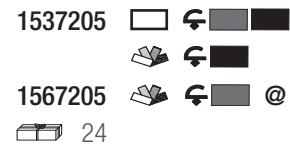

35 x 20

	1261831	1261841
→↯←	1,5	2
lx	2,5	3,1
ly	0,56	0,69
	6	6

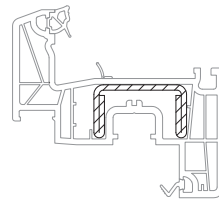

35 x 20

	1351893
→↯←	2
lx	3,8
ly	0,77
	6

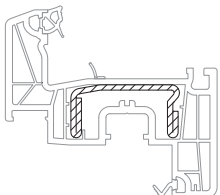

41 x 20

	1357590
→↯←	2
lx	4,9
ly	0,8
	6

Flügel

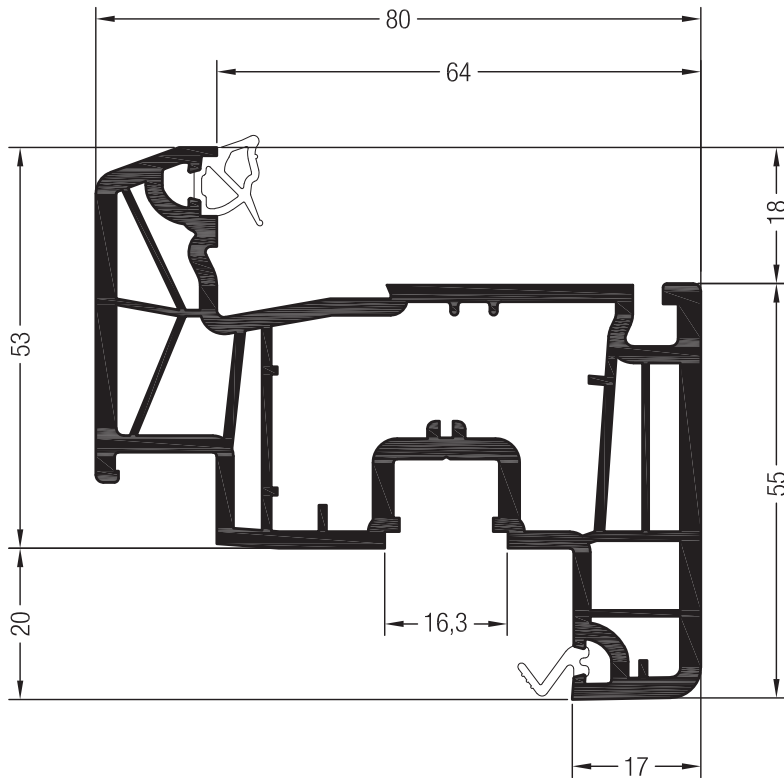

Klebeflügel Z53 PULS SYNEGO®

1537285



1567285



24

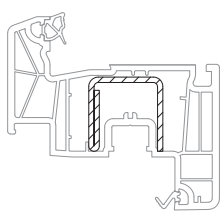

28 x 28

	1357610	1313130
	1,5	2
lx	2	2,5
ly	1,2	1,6
	6	6

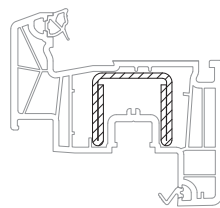

30 x 28

	1306617
	2
lx	3,7
ly	1,9
	6

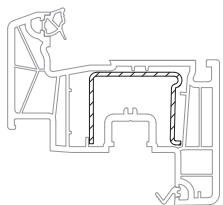

35 x 28

	1244506
	1,5
lx	2,5
ly	1,1
	6

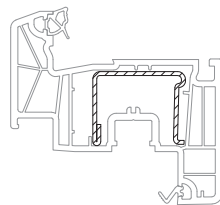

35 x 28

	1244516	1244526
	1,5	2
lx	2,7	3,5
ly	1,3	1,7
	6	6

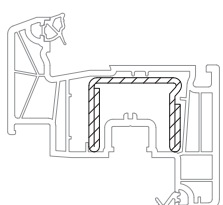

35 x 28

	1244536
	2
lx	5
ly	2
	6

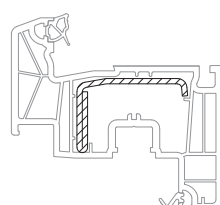

41,8 x 28

	1352515
	2
lx	3,3
ly	1,4
	6

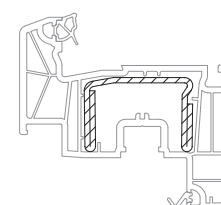

41 x 28

	1352512
	2
lx	7,1
ly	2,1
	6

Flügel

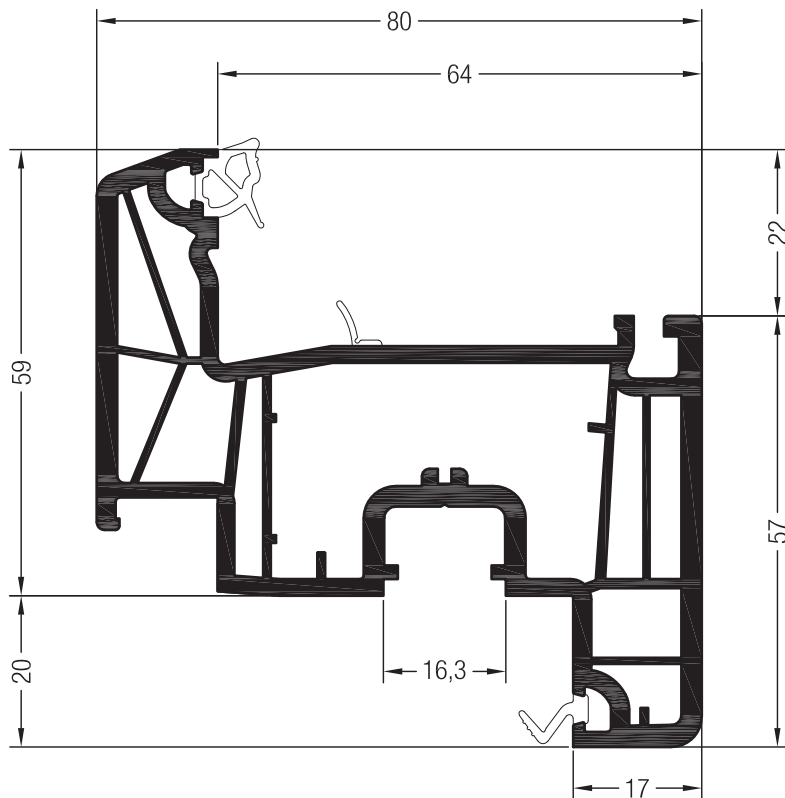

Flügel Z59 PULS SYNEGO®

1537525



1567525



24

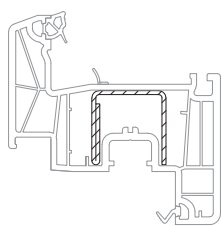

28 x 28

	1357610	1313130
	1,5	2
lx	2	2,5
ly	1,2	1,6
	6	6

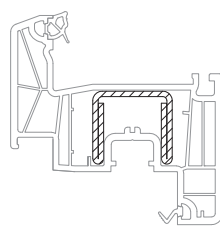

30 x 28

	1306617
	2
lx	3,7
ly	1,9
	6

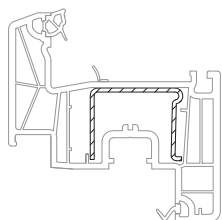

35 x 28

	1244506
	1,5
lx	2,5
ly	1,1
	6

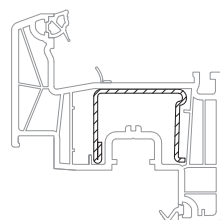

35 x 28

	1244516	1244526
	1,5	2
lx	2,7	3,5
ly	1,3	1,7
	6	6

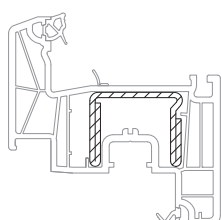

35 x 28

	1244536
	2
lx	5
ly	2
	6

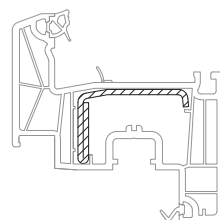

41,8 x 28

	1352515
	2
lx	3,3
ly	1,4
	6

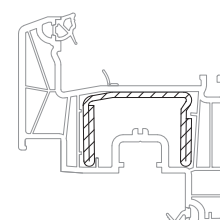

41 x 28

	1352512
	2
lx	7,1
ly	2,1
	6

Flügel

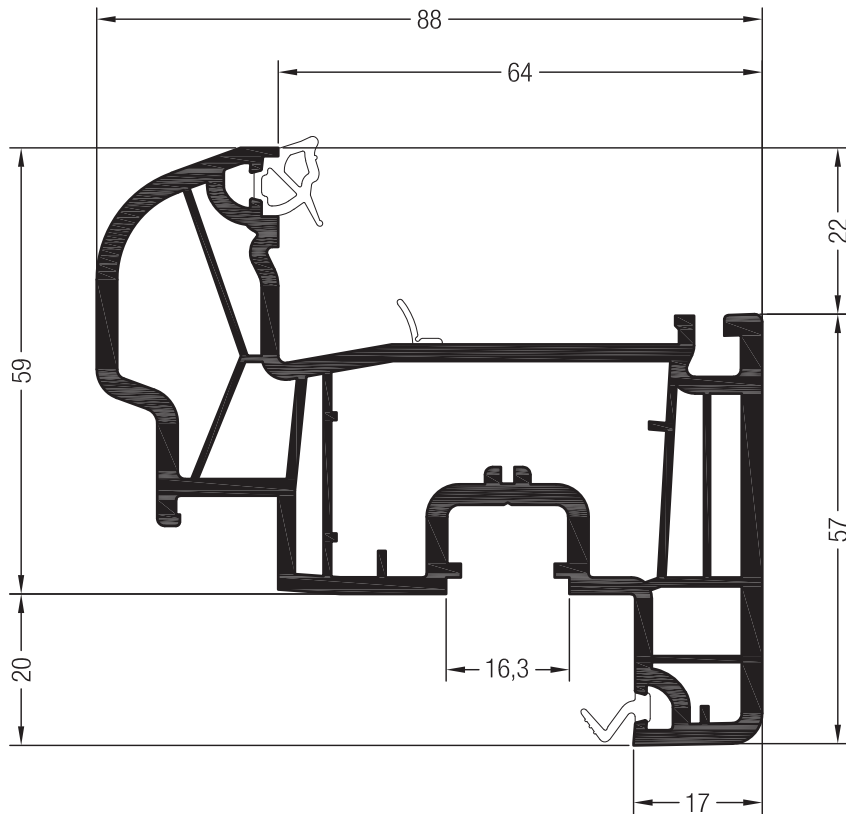

Flügel 59 rund SYNEGO®

- 1537245
- 1567245
- @
- 24

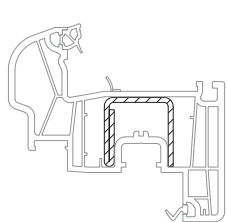

28 x 28

	1357610	1313130
	1,5	2
lx	2	2,5
ly	1,2	1,6
	6	6

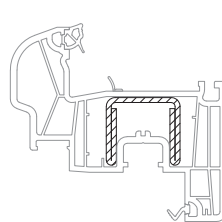

30 x 28

	1306617
	2
lx	3,7
ly	1,9
	6

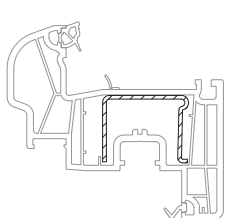

35 x 28

	1244506
	1,5
lx	2,5
ly	1,1
	6

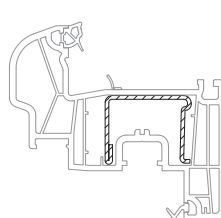

35 x 28

	1244516	1244526
	1,5	2
lx	2,7	3,5
ly	1,3	1,7
	6	6

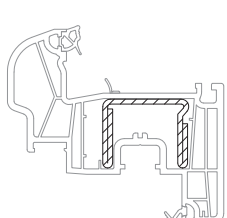

35 x 28

	1244536
	2
lx	5
ly	2
	6

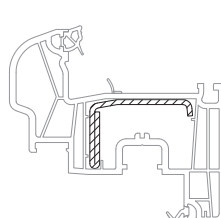

41,8 x 28

	1352515
	2
lx	3,3
ly	1,4
	6

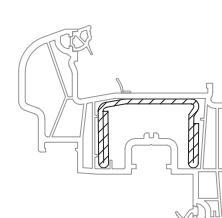

41 x 28

	1352512
	2
lx	7,1
ly	2,1
	6

Flügel

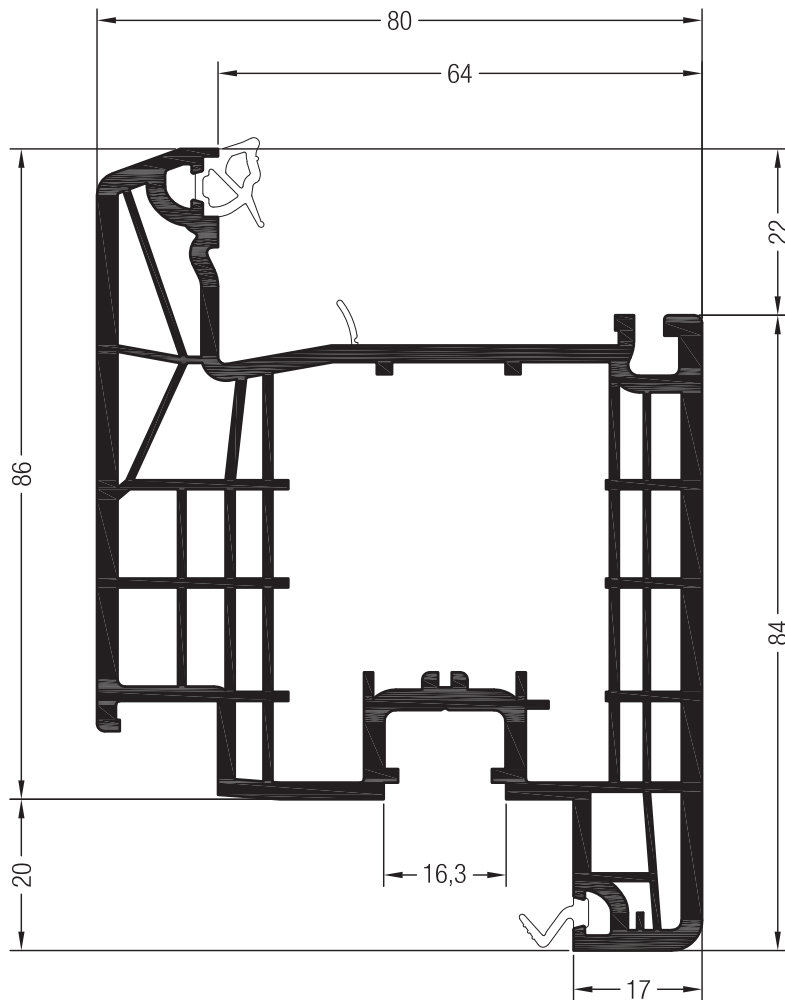

Flügel Z86 SYNEGO®

- 1537535
- 1567535
- @
- 24

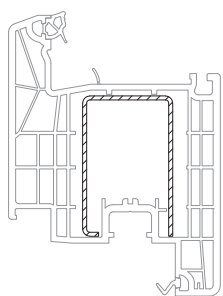

34 x 53

	1357547
	1,5
lx	4,6
ly	6,5
	6

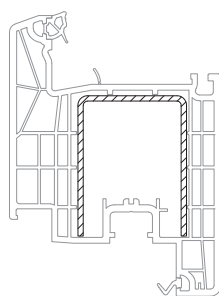

41 x 53

	1357548
	2
lx	8,7
ly	8,4
	6

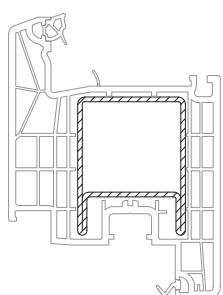

41 x 52

	1357597
	1,75
lx	9,7
ly	10,5
	6

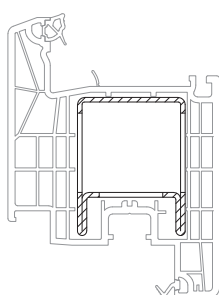

41 x 52

	1357598
	1,75
konfektioniert für Schloss	
	2,2

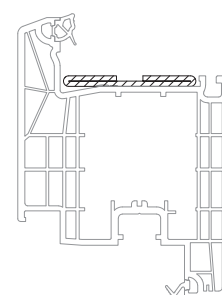

50 x 4

	1320701
	2
Armierung HT-Falz f. Sanierung	
	1,9

Flügel

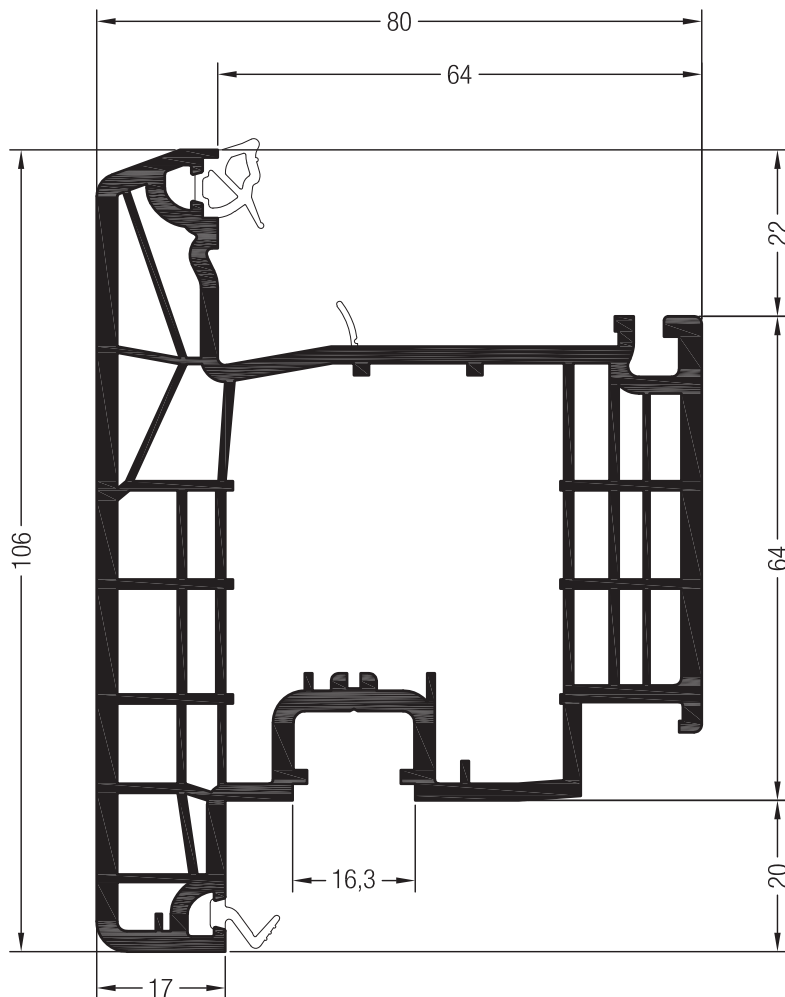

Flügel T106 SYNEGO®

- 1537545
-
- 1567545
- @
- 12

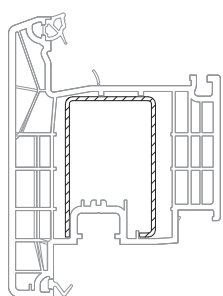

34 x 53	
	1357547
	1,5
lx	4,6
ly	6,5
	6

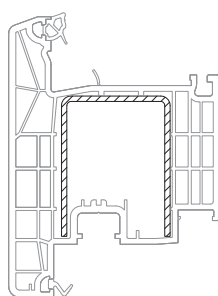

41 x 53	
	1357548
	2
lx	8,7
ly	8,4
	6

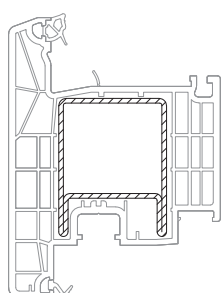

41 x 52	
	1357597
	1,75
lx	9,7
ly	10,5
	6

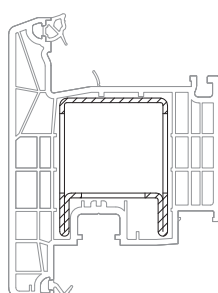

41 x 52	
	1357598
	1,75
konfektioniert für Schloss	
	2,2

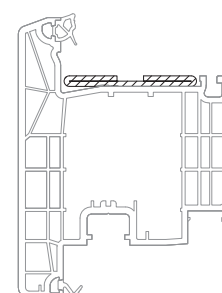

50 x 4	
	1320701
	2
Armierung HT- Falz f. Sanierung	
	1,9

Flügel

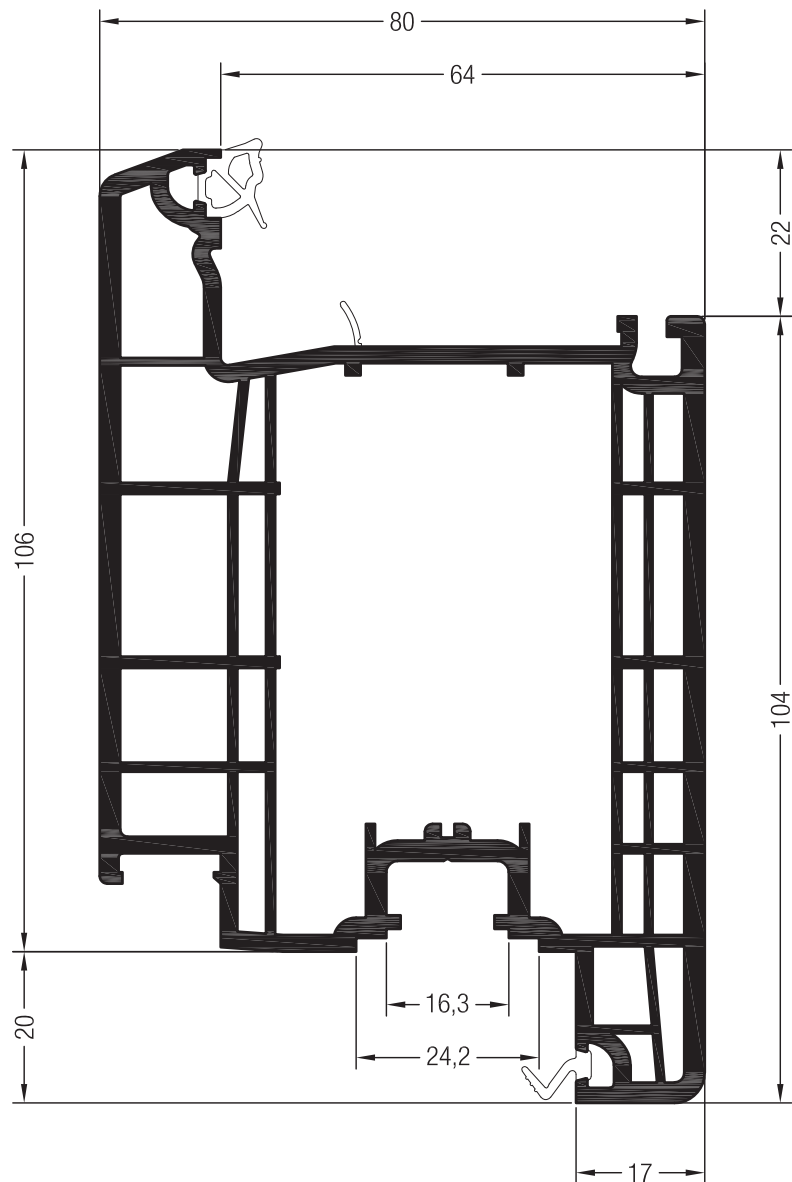

Haustürflügel Z SYNEGO®

- 1537295
-
- 1567295
- @
- 13

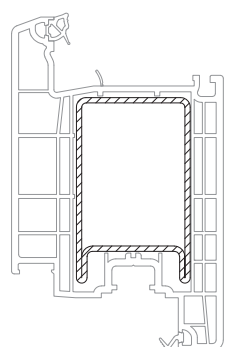

43 x 70

	1357549
	2
lx	14,9
ly	27,1
	6

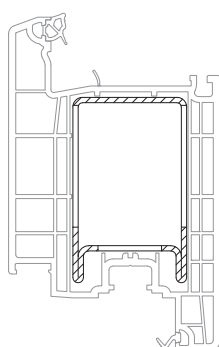

43 x 70

	1357556
	2
konfektioniert für Schloss	
	2,4

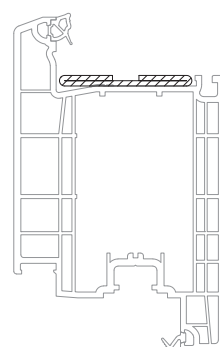

50 x 4

	1320701
	2
Armierung HT-Falz f. Sanierung	
	1,9

Flügel

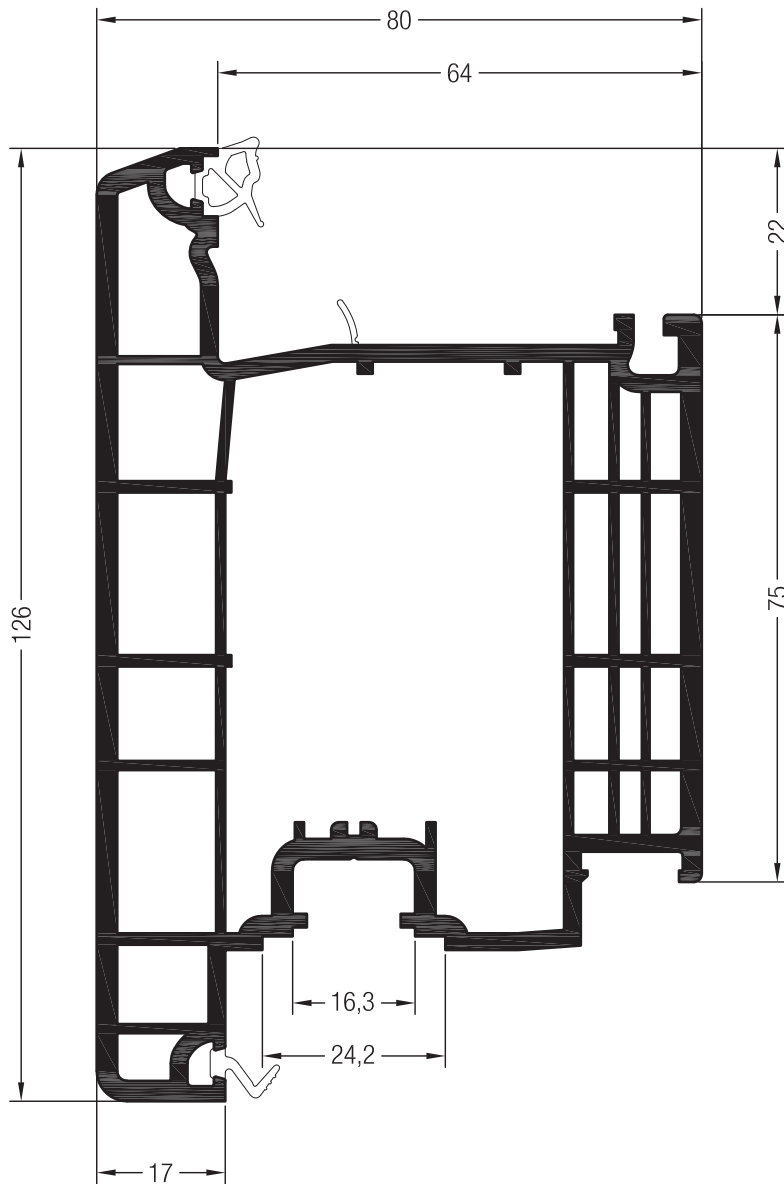

Haustürflügel T SYNEGO®

- 1537305
-
- 1567305
- @
- 13

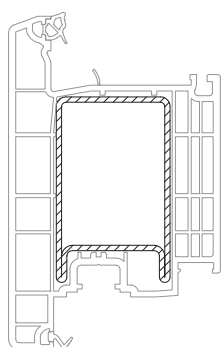

43 x 70

	1357549
	2
lx	14,9
ly	27,1
	6

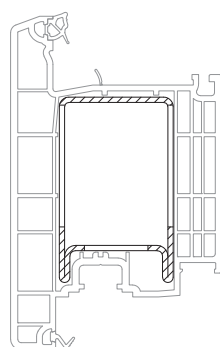

43 x 70

	1357556
	2
konfektioniert für Schloss	
	2,4

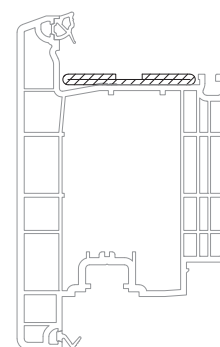

50 x 4

	1320701
	2
Armierung HT-Falz f. Sanierung	
	1,9

Flügelsprossen

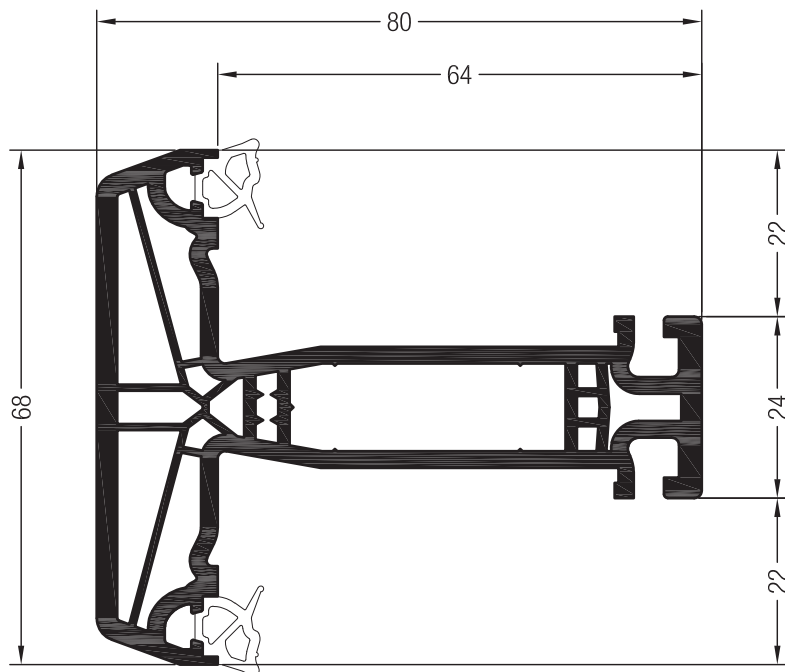

Sprosse 68 SYNEGO®

1537425    



1567425   

    @

 36

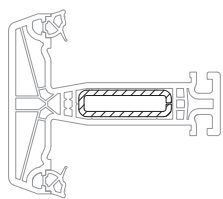

35 x 10

	1261801
	2
lx	1,8
ly	0,22
	6

Flügelprossen

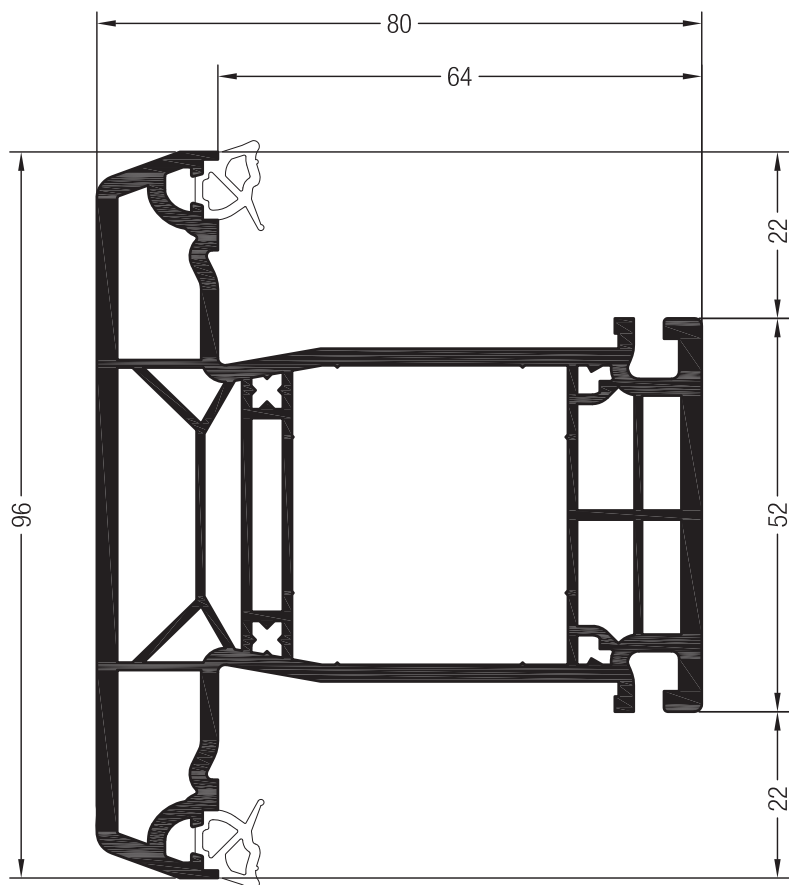

Sprosse 96 SYNEGO®

1537435   



1567435  

   @

 24

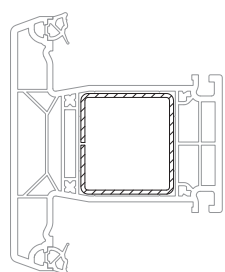

35 x 38

	1357609
	1,5
lx	3,8
ly	4,4
	6

Profile für mehrflügelige Fenster ohne festen Pfosten

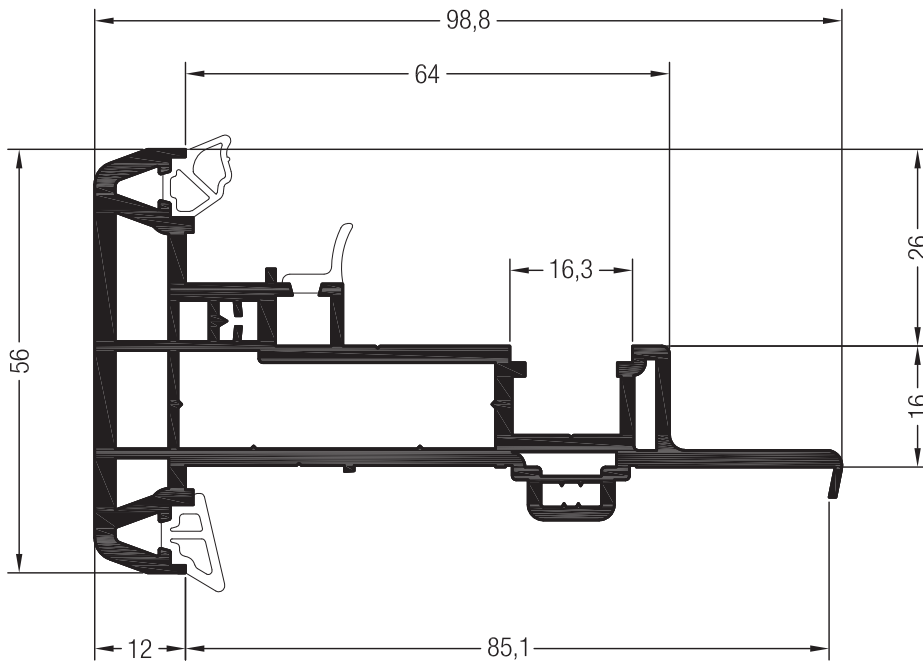

Stulpprofil SYNEGO®

1537445   

1567445   



 24



Stulpprofil SYNEGO®

für Alu-Vorsatzschale (ohne Universal- und Stulpdichtung)

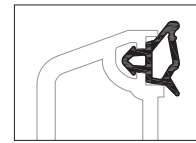

1537440 

 24



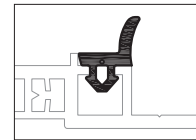

	1357451
	1357451



	1357443
	1357443

40 x 10

	1247898
	2
lx	2,7
ly	0,25
	6

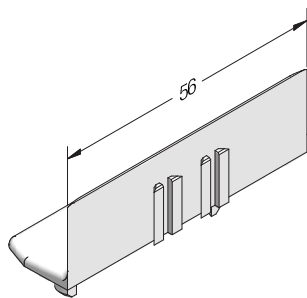
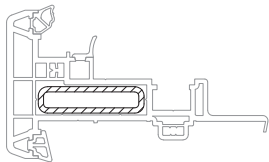

Endkappe Stulpprofil außen SYNEGO®

ASA

1358024    

 50

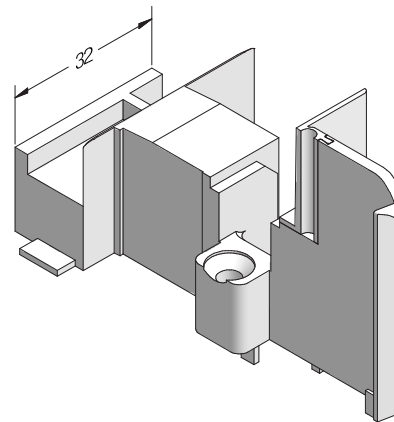

Endkappe Stulpprofil innen SYNEGO®

ASA/TPE

1358026    

1358027    

 50

SYNEGO®

PROFILDRUCK

Profile für mehrflügelige Fenster ohne festen Pfosten

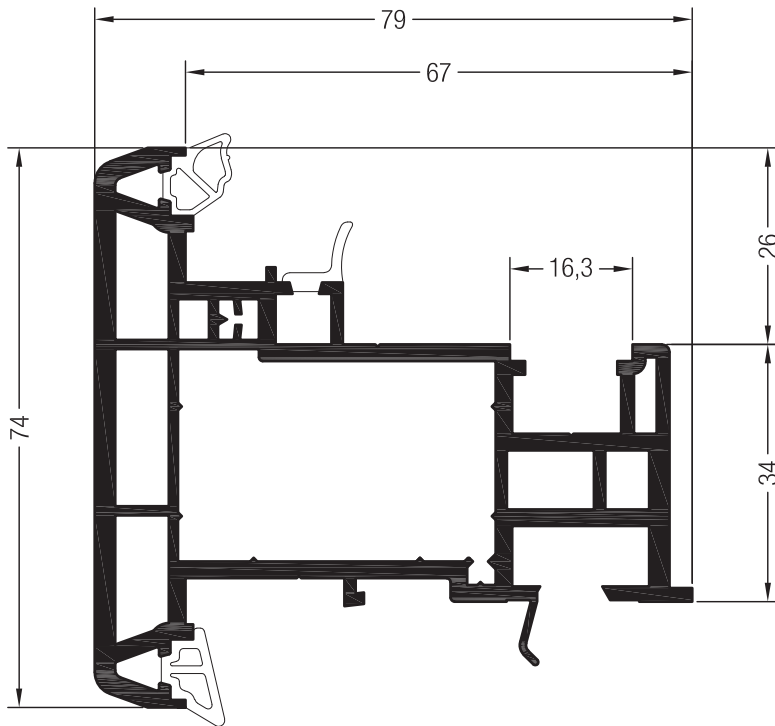

Blindpfosten SYNEGO®

1537455

1567455

24

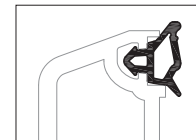

E

	1357451
	1357451

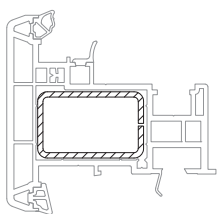

40 x 25

	1357552
	2
lx	4,8
ly	2,3
	6

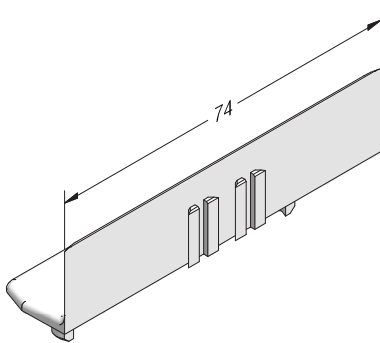

Endkappe Blindpfosten außen SYNEGO®

ASA

1358034

50

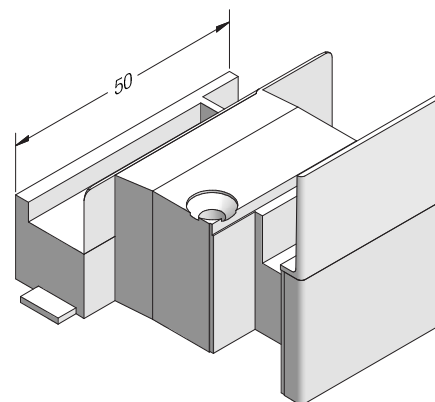

Endkappe Blindpfosten innen SYNEGO®

ASA/TPE

1358036

1358037

50

Profile für mehrflügelige Fenster ohne festen Pfosten

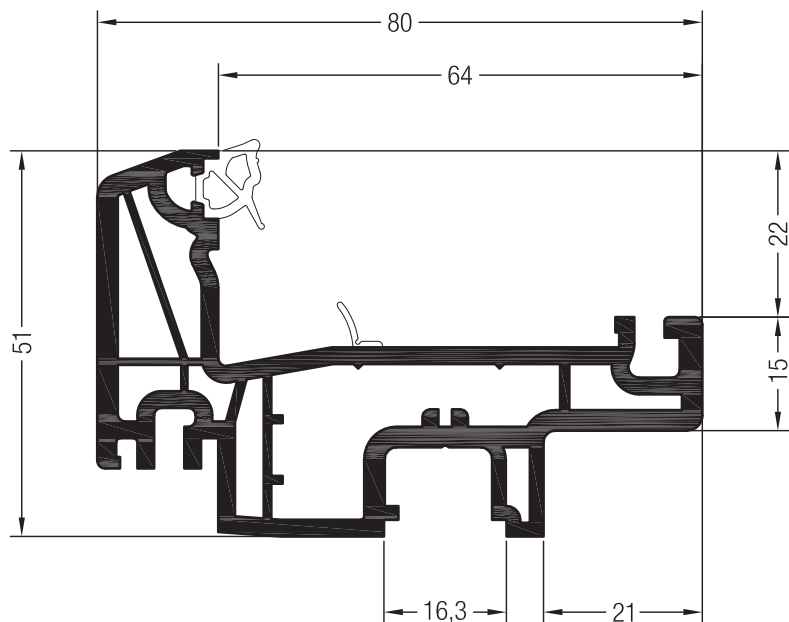

Stulpflügel Z51 SYNEGO®

1537475

1567475

24

35 x 19

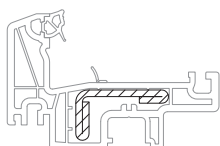

	1351875
	2,5
lx	2,5
ly	0,53
	6

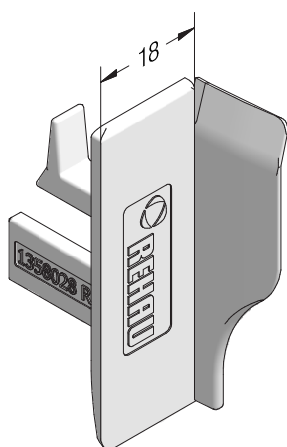

Endkappe Stulpflügel SYNEGO®

TPE

1358028

1358029

50

Profile für mehrflügelige Fenster ohne festen Pfosten

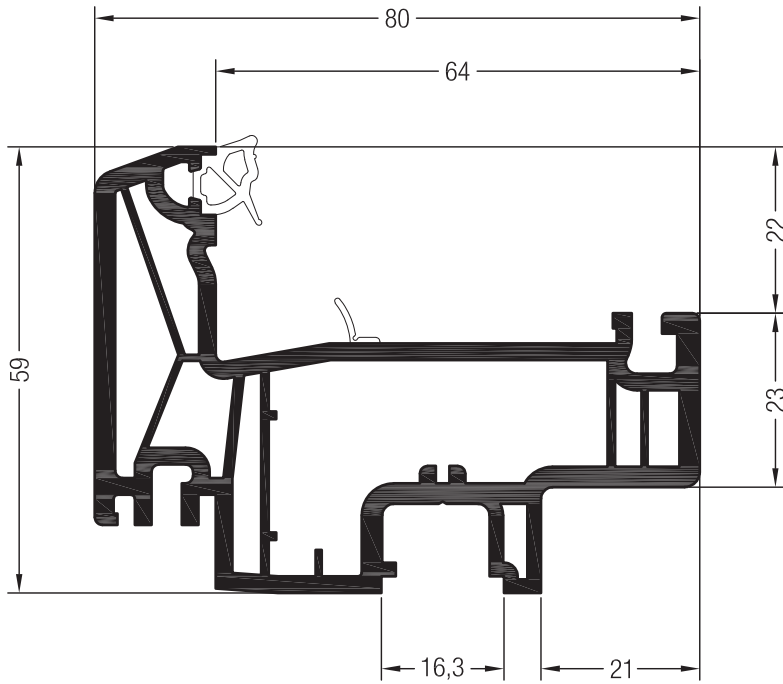

Stulpflügel Z59 SYNEGO®

1537485

1567485

24

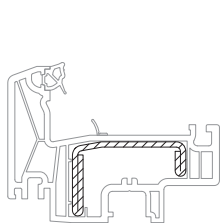

42,8 x 28

	1357554
	2
lx	5,6
ly	1,4
	6

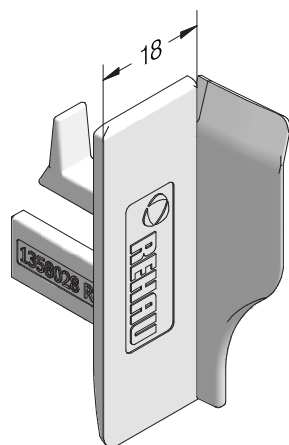

Endkappe Stulpflügel SYNEGO®

TPE

1358028

1358029

50

Profile für mehrflügelige Fenster ohne festen Pfosten

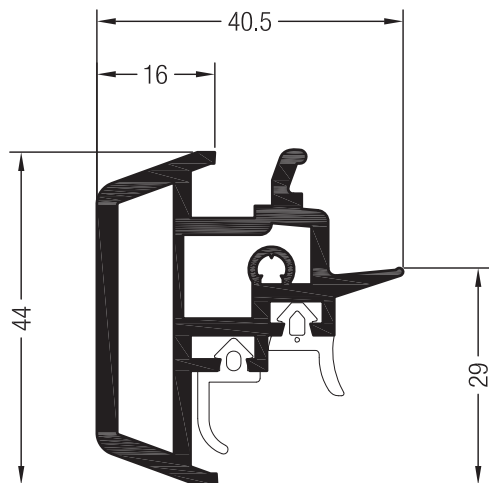

Stulpleiste SYNEGO®

1537495 

1567495 

 36

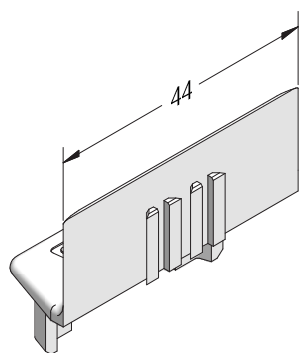

Endkappe Stulpleiste außen SYNEGO®

ASA

1358110 

 50

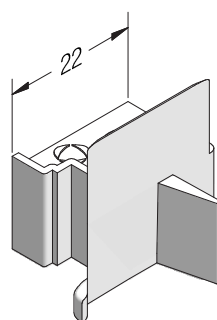

Endkappe Stulpleiste innen SYNEGO®

ASA



1358038 

1358039 

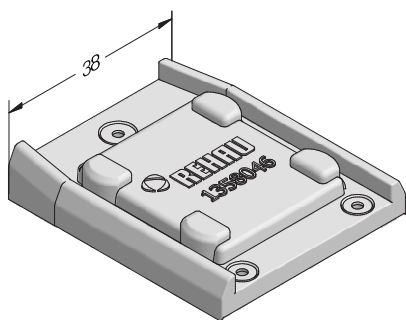

 50

Zubehör für mechanische Verbindungen



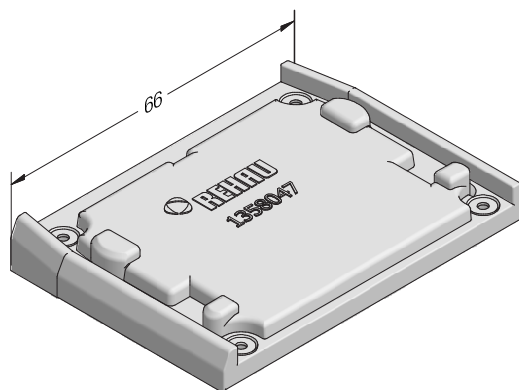

Mechanischer Verbinder Pfosten 96 AD SYNEGO®
TPE
1358046 
 50



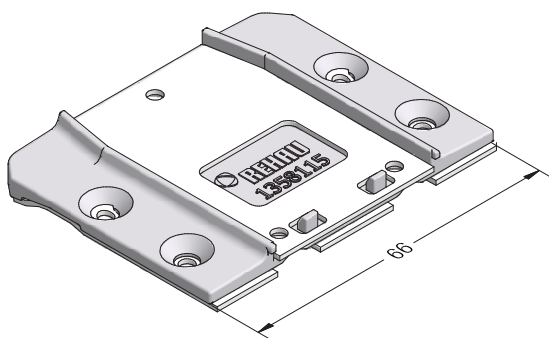

Mechanischer Verbinder Pfosten 124 AD SYNEGO®
TPE
1358047 
 50



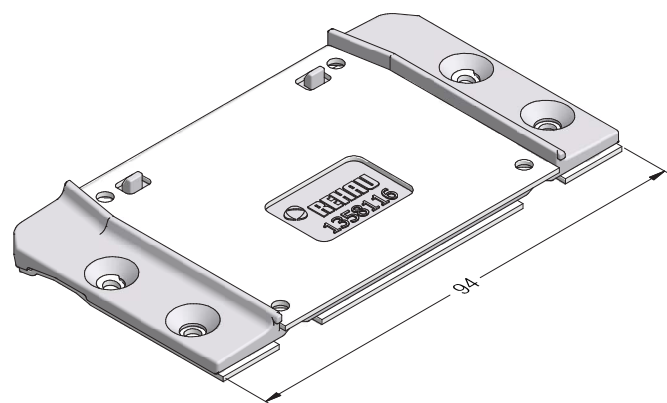

Mechanischer Verbinder Pfosten 96 AD SYNEGO®
Zink-Druckguss
1358115 
 50





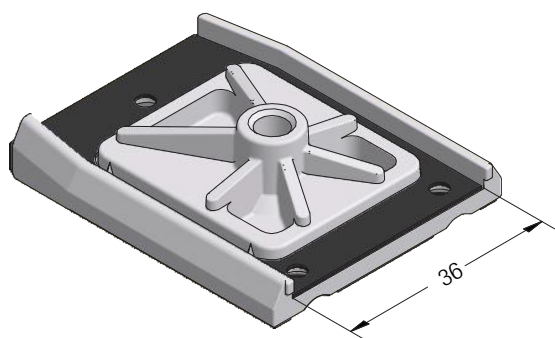

Mechanischer Verbinder Pfosten 124 AD SYNEGO®
Zink-Druckguss
1358116 
 50

Zubehör für mechanische Verbindungen

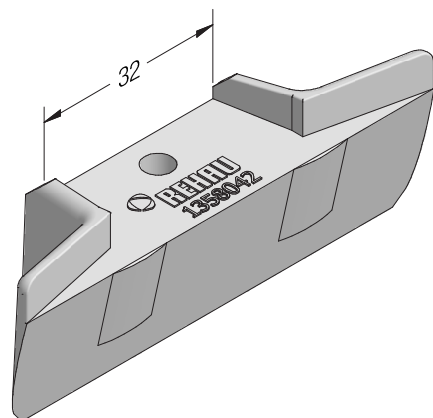

Mechanischer Verbinder Pfosten 96 AD SYNEGO®
 Zink-Druckguss
1358122 
 50



Dichtblock Pfosten 96 MD SYNEGO®
 TPE
1358042  
 50

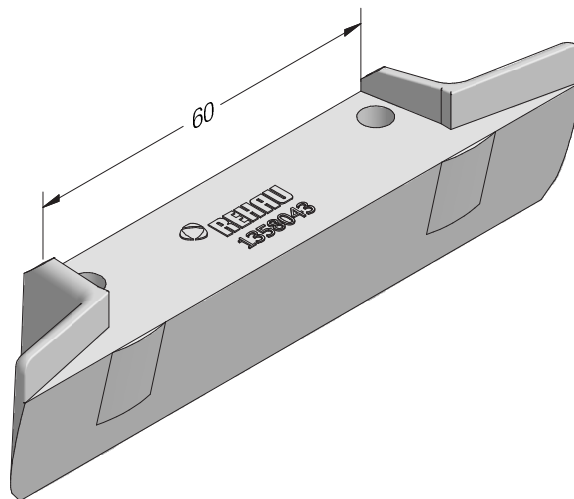

Dichtblock Pfosten 124 MD SYNEGO®
 TPE
1358043  
 50

Zubehör für mechanische Verbindungen

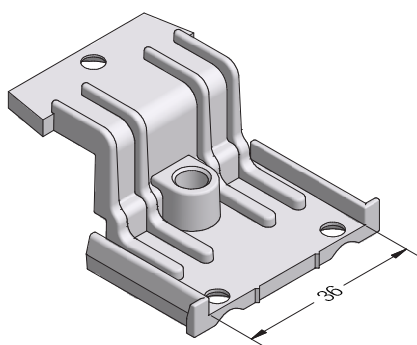

Mechanischer Verbinder Pfosten 96 MD SYNEGO®

Zink-Druckguss

1358118 

 50

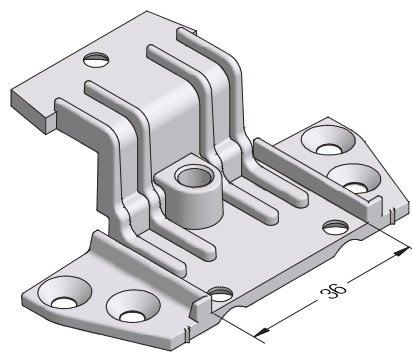

Mechanischer Verbinder Pfosten 96 MD SYNEGO® Kreuzstoß

Zink-Druckguss

1358119 

 50

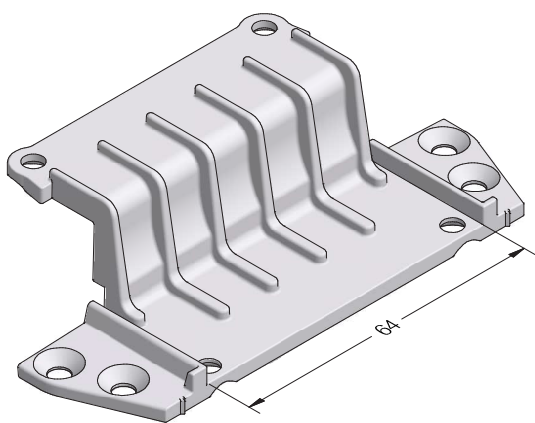

Mechanischer Verbinder Pfosten 124 MD SYNEGO® Kreuzstoß

Zink-Druckguss

1358128 

 50

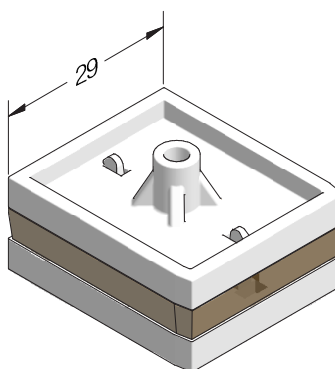

Dichtteil Pfosten 96 MD SYNEGO®

PA/TPE

1358058 

 50

Zubehör für mechanische Verbindungen

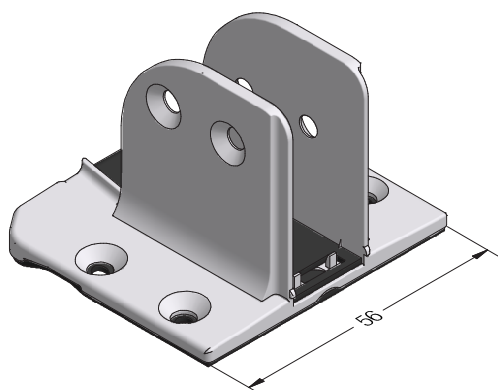

Mechanischer Verbinder Sprosse 68 SYNEGO®

Zink-Druckguss

1358044 

 50

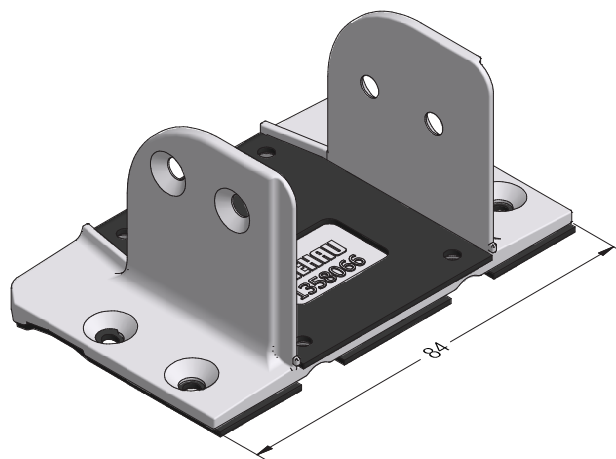

Mechanischer Verbinder Sprosse 96 SYNEGO®

Zink-Druckguss

1358066 

 50

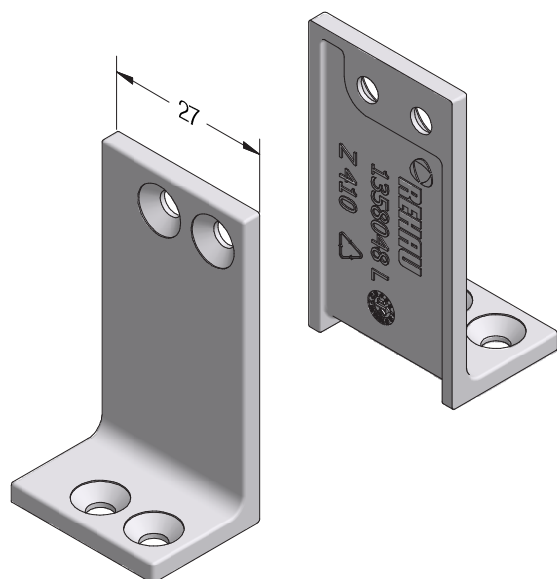

Set Pfostenwinkel Kreuzstoß Pfosten MD SYNEGO®

Zink-Druckguss

1358048 

 20

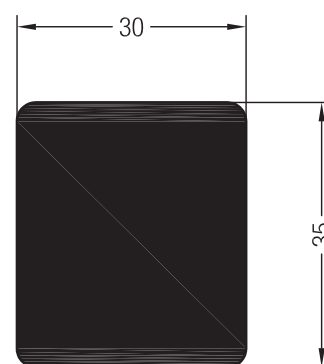

Mechanischer Verbinder universal Pfosten 96 SYNEGO®

30 x 35

1358033 

 2

Zubehör für mechanische Verbindungen

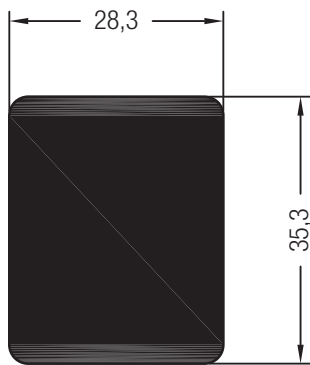

Mechanischer Verbinder universal (für Ausgleichsprofil 48)

35 x 28

1260448 

 2

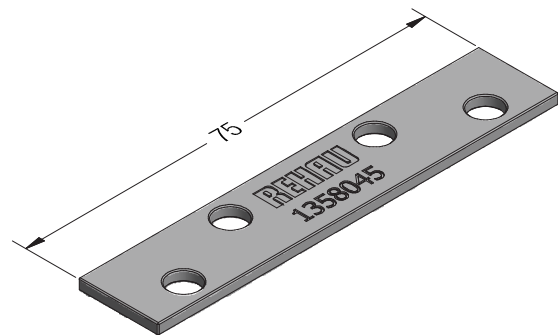

Montageplatte Pfosten 96 und 124 SYNEGO®

Stahl verzinkt

1358045 

 400

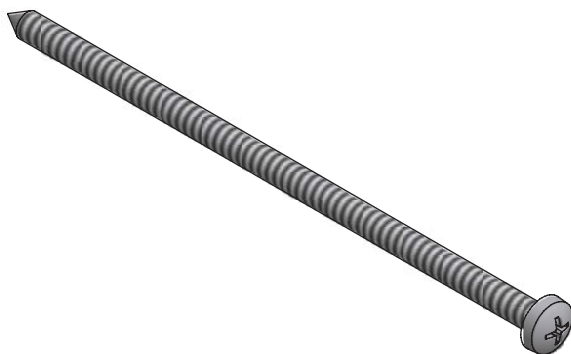

Blechschaube ISO 7049, 4,2 x 100

Stahl verzinkt

1247725

 200

Blechschaube ISO 7049, 4,2 x 120

Stahl verzinkt

1207679

 100

Bodenschwelle und Zubehör

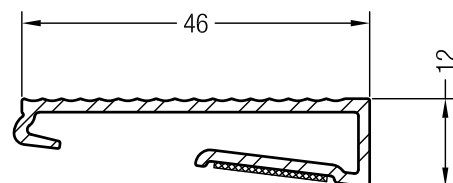
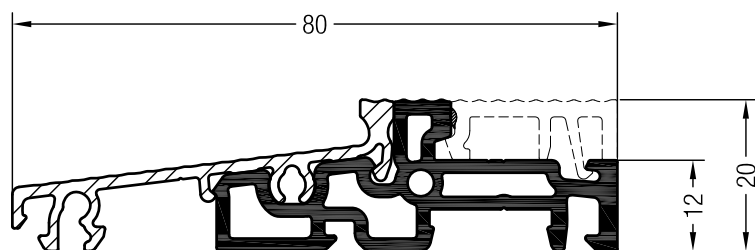
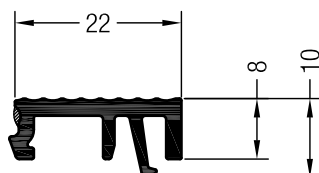

Set Bodenschwelle Bautiefe 80

1356663

6

Deckelprofil auswärts öffnend Bautiefe 80

1356673

6

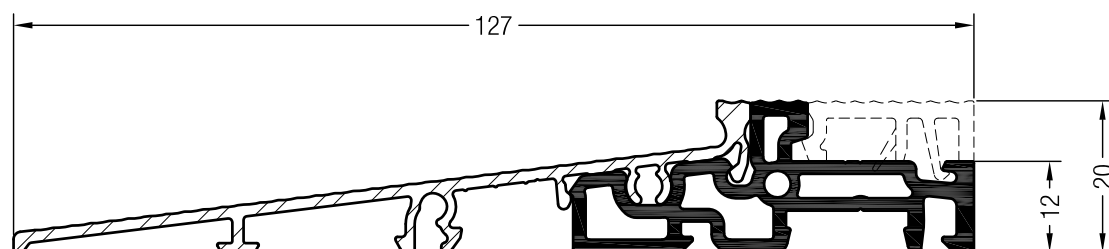
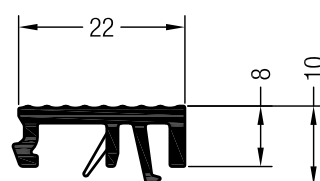

Set Bodenschwelle 127 SYNEGO® (nur für Elemente mit Rollläden)

1358663

6

Bodenschwelle und Zubehör

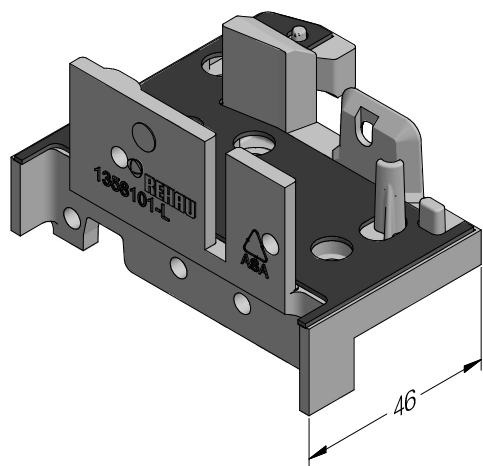

Schwellenhalter Blendrahmen 72 SYNEGO®

ASA



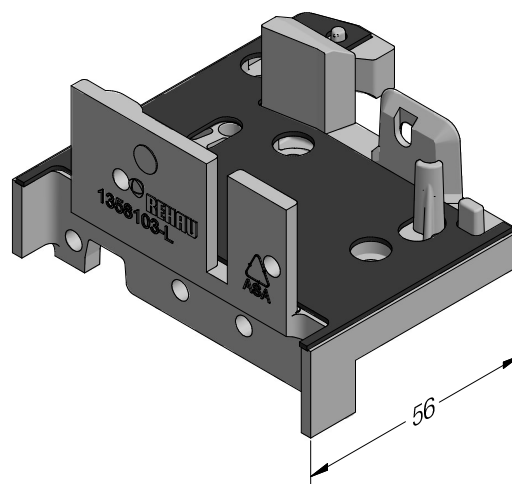

1358100  
 1358101  

 50



Schwellenhalter Blendrahmen 82 SYNEGO®

ASA



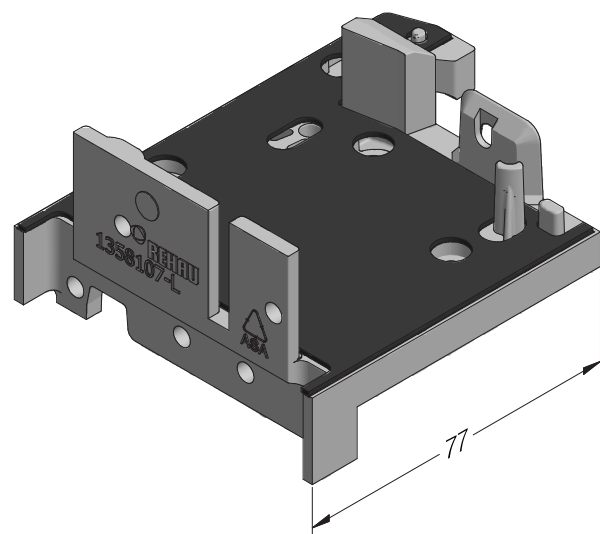

1358102  
 1358103  

 50



Schwellenhalter Blendrahmen 103 SYNEGO®

ASA

1358106  
 1358107  

 50

Bodenschwelle und Zubehör

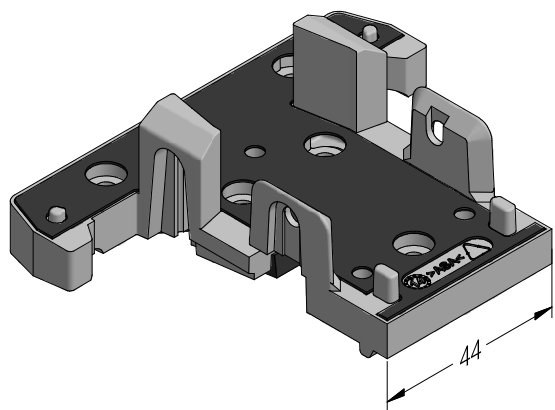

Schwellenhalter Pfosten 96 SYNEGO®

ASA

1358104 ■

 50

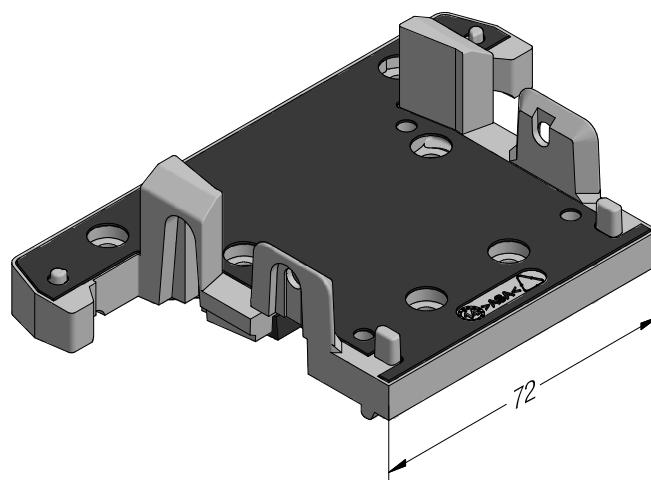

Schwellenhalter Pfosten 124 SYNEGO®

ASA

1358105 ■

 50

Bodenschwelle und Zubehör

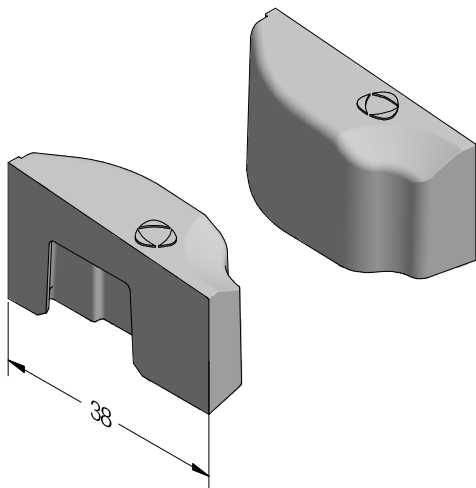

Set Windstopp AD SYNEGO®

TPE

1358108 

 50

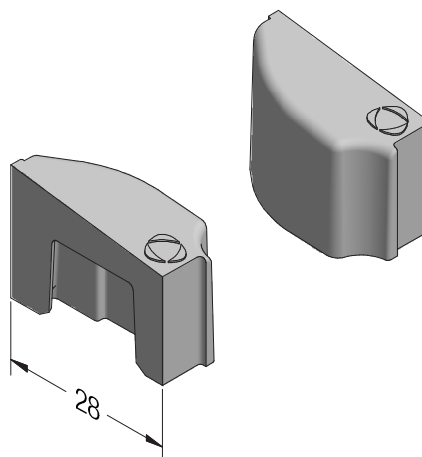

Set Windstopp MD SYNEGO®

TPE

1358109 

 50

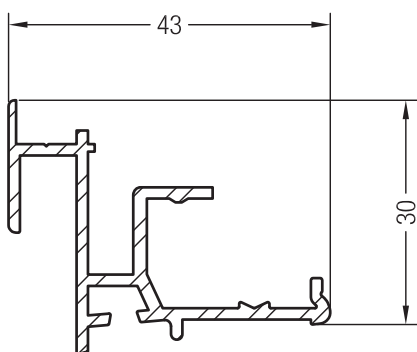



Ausgleichsprofil SYNEGO®

1357344 

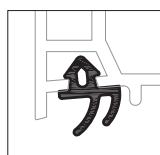
 6



	1211738
	1211728
	400

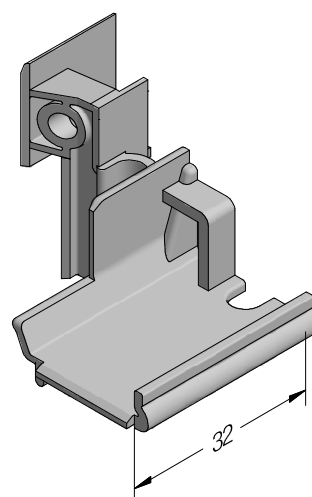

Endkappe Ausgleichsprofil SYNEGO®

ASA

1358056 

1358057 

 50

Bodenschwelle und Zubehör

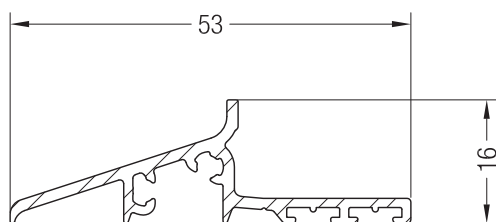



Wetterschenkel SYNEGO®

1357341 

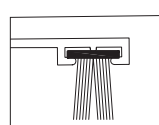
 6



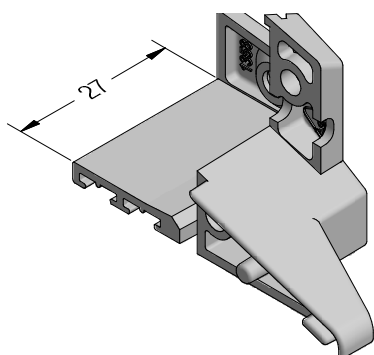

	1248095
	50



Endkappe Wetterschenkel SYNEGO®

ASA

1358052  

1358053  

 50

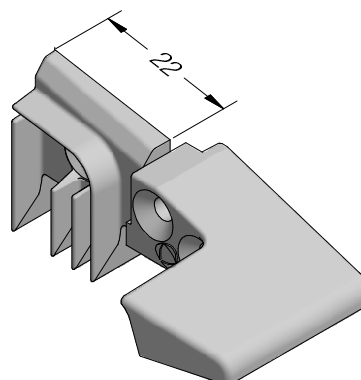

Endkappe Wetterschenkel Stulp SYNEGO®

TPE

1358054  

1358055  

 50

Bodenschwelle und Zubehör

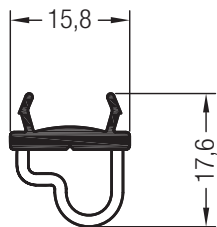

Kältestopp

1353383 

 6

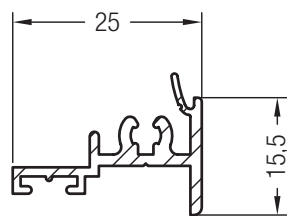



Deckleiste Flügel T SYNEGO®

1353550 

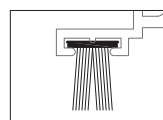
 6



	1248095
	50

Zubehör auswärts öffnende Elemente

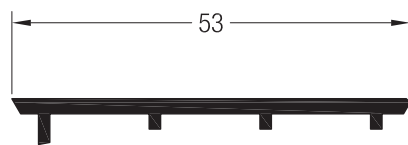

Falzeinlageprofil SYNEGO®

1537340 

 72

Zubehör für Haus- und Nebeneingangstüren

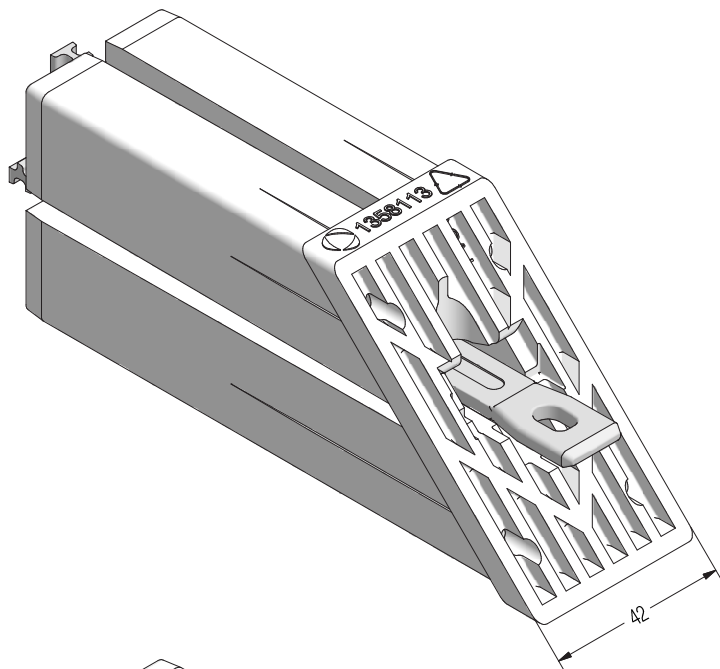

Schweißbarer Eckverbinder HT-Flügel SYNEGO®

PVC-U

1358113 

 96

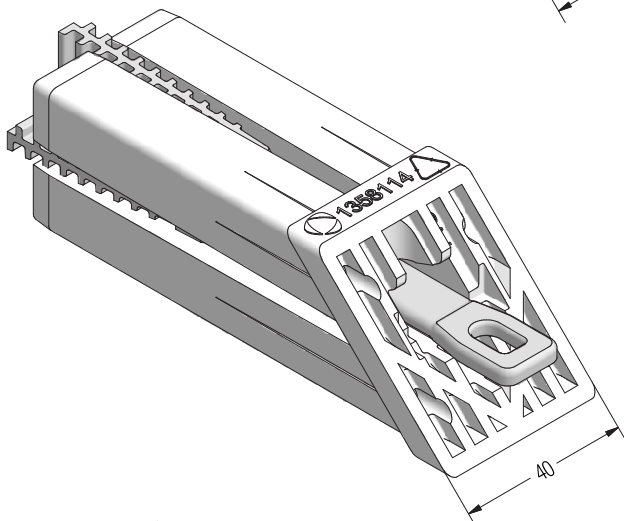

Schweißbarer Eckverbinder Flügel 86/106 SYNEGO®

PVC-U

1358114 

 96

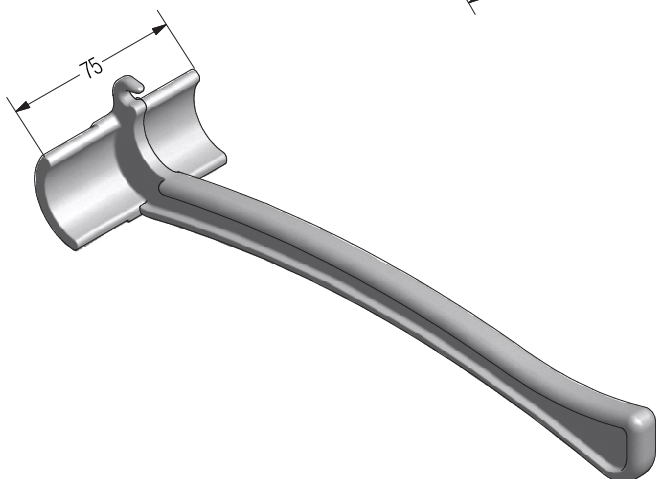

Spannhebel

Zink-Druckguss

1353616 

 1

Bohrlehren

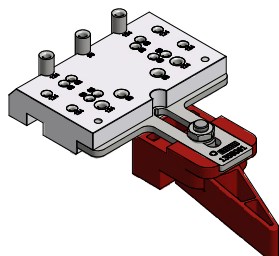

Bohrlehre mech. Verbinder Pfosten/Sprosse AD SYNEGO®
(Bohrlehre für Blendrahmen SYNEGO® AD,
Bohrlehre für Pfosten SYNEGO® AD in Verbindung mit Kreuzstoß,
Bohrlehre Flügel SYNEGO® in Verbindung mit Sprosse 68 SYNEGO®)

1358061



1

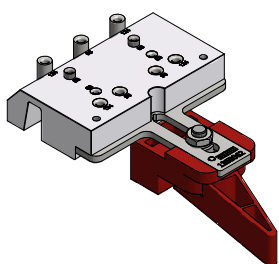

Bohrlehre mech. Verbinder Pfosten/Sprosse MD SYNEGO®
(Bohrlehre für Blendrahmen SYNEGO® MD,
Bohrlehre für Flügel SYNEGO® in Verbindung mit Sprosse 68 SYNEGO®)

1358062



1

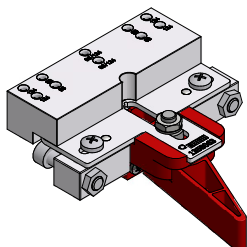

Bohrlehre mech. Verbinder Pfostenwinkel SYNEGO®
(Bohrlehre für Pfosten SYNEGO® MD in Verbindung mit Kreuzstoß)

1358063



1

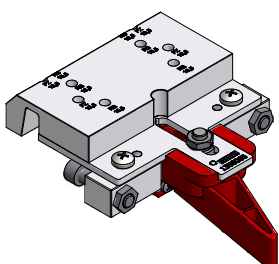

Bohrlehre Schwellenhalter SYNEGO®
(Bohrlehre für Blendrahmen und Pfosten SYNEGO® AD/MD)

1358065



1

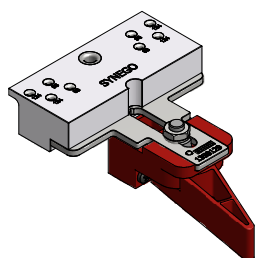

Bohrlehre mech. Verbinder Pfosten 96/124 MD SYNEGO®
(Bohrlehre für Blendrahmen und Pfosten 96/124 SYNEGO® MD)

1358129



1

Bohrlehren

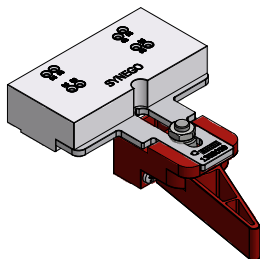

Bohrlehre mech. Verbindersprossen
(Bohrlehre für Flügel und Sprossen 68/96 SYNEGO®)

1358059



1

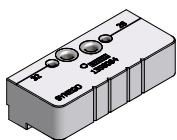

Bohrlehre Elementkopplung und Montage SYNEGO®

1358064



1

Armierungen

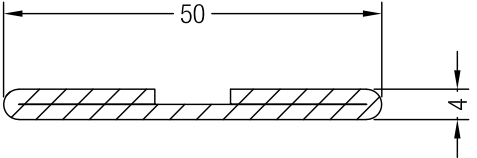
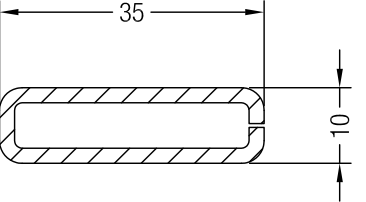
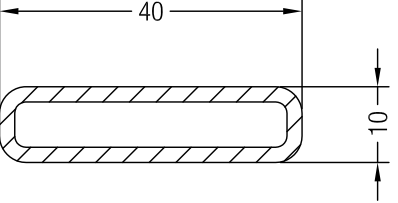
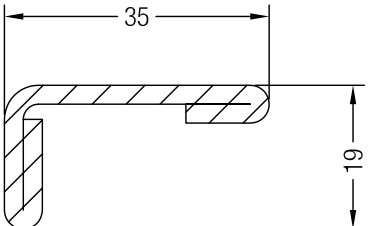
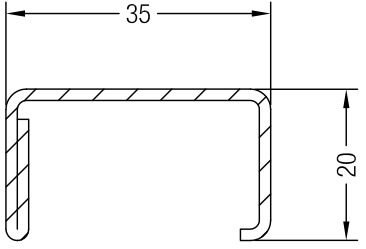
	Art.-Nr.		lx	ly
	1320701	2	3,9	0,02
	1261801	2	1,8	0,22
	1247898	2	2,7	0,25
	1351875	2,5	2,5	0,53
	1261831	1,5	2,5	0,56
	1261841	2	3,1	0,69

Armierungen

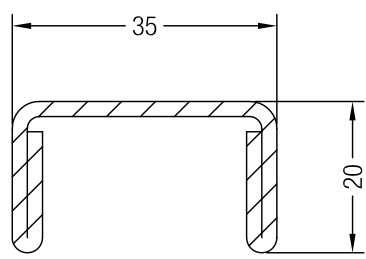
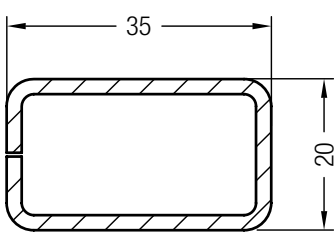
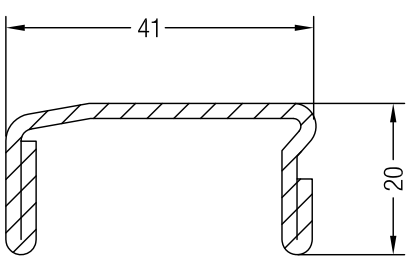
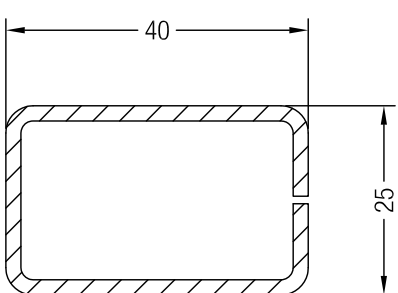
	Art.-Nr.		lx	ly
	1351893	2	3,8	0,77
	1239583	1,5	2,3	0,98
	1357590	2	4,9	0,8
	1357552	2	4,8	2,3

Armierungen

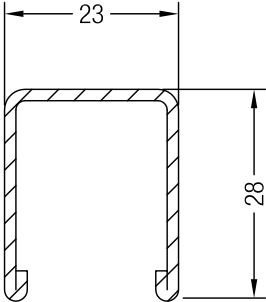
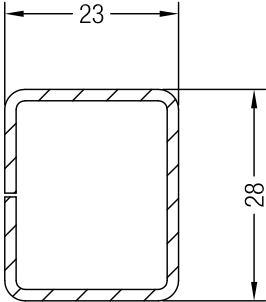
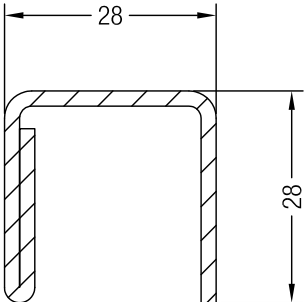
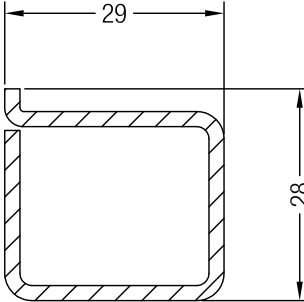
	Art.-Nr.		lx	ly
	1306619	1,5	1,1	1,1
	1357540	1,5	1,1	1,5
	1357610	1,5	2	1,2
	1313130	2	2,5	1,6
	1357550	2	2,3	1,8

Armierungen

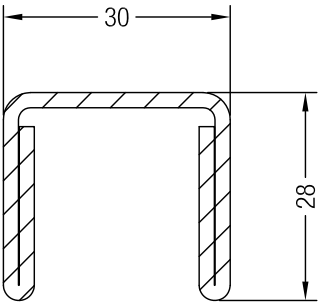
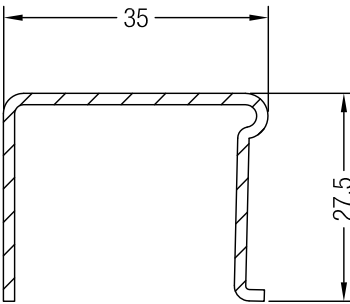
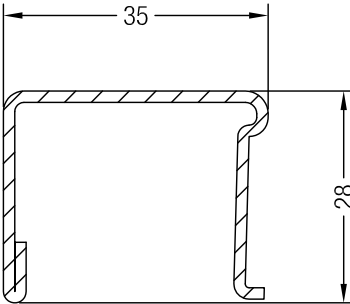
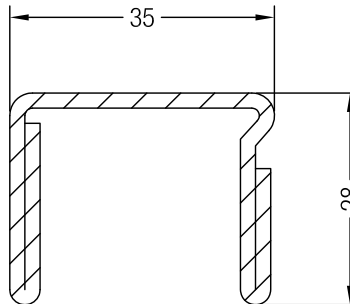
	Art.-Nr.		lx	ly
	1306617	2	3,7	1,9
	1244506	1,5	2,5	1,1
	1244516	1,5	2,7	1,3
	1244526	2	3,5	1,7
	1244536	2	5	2

Armierungen

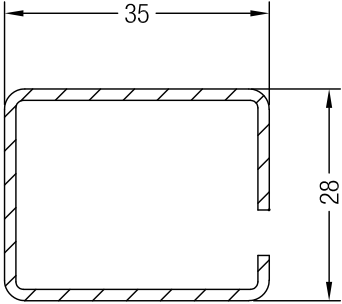
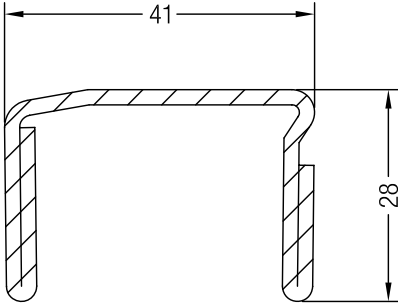
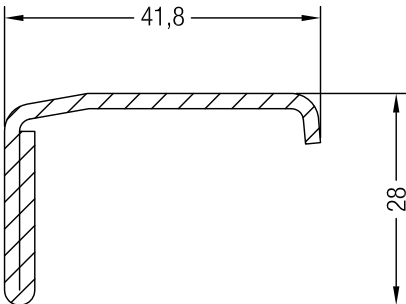
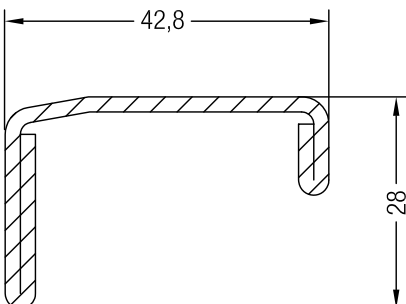
	Art.-Nr.		lx	ly
	1237091	1,5	2,8	2,1
	1352512	2	7,1	2,1
	1352515	2	3,3	1,4
	1357554	2	5,6	1,4

Armierungen

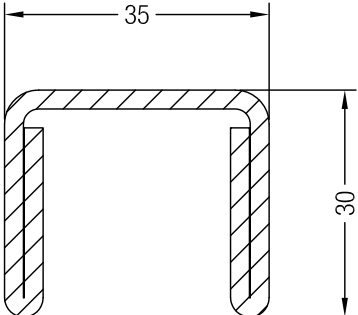
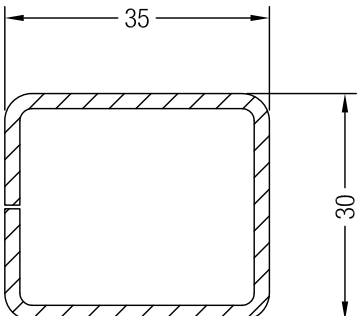
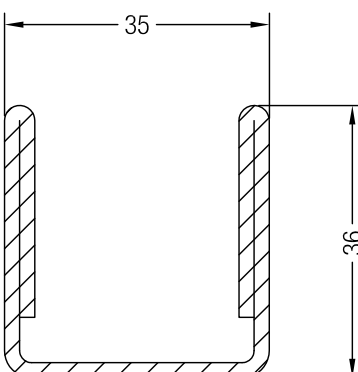
	Art.-Nr.		lx	ly
	1357551	2,5	6,6	2,9
	1357666	1,5	3,2	2,5
	1357544	2	4	3,1
	1357608	2	6,6	3,9

Armierungen

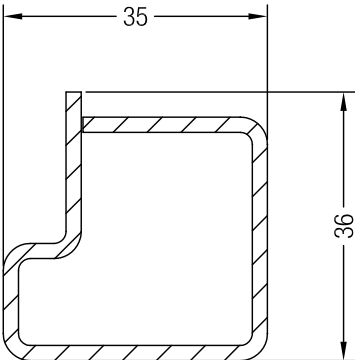
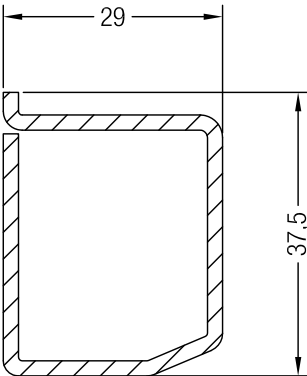
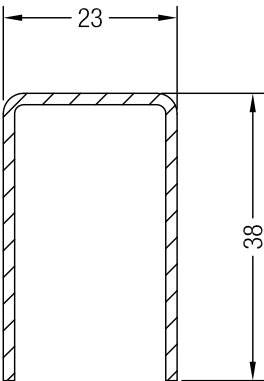
	Art.-Nr.		lx	ly
	1357543	2	3,6	3,7
	1357559	2	2,9	3,9
	1357541	1,5	1,4	2,1

Armierungen

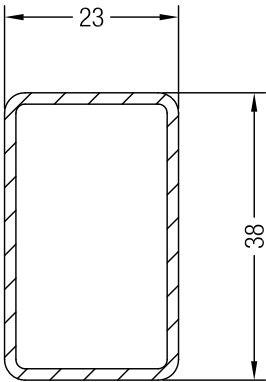
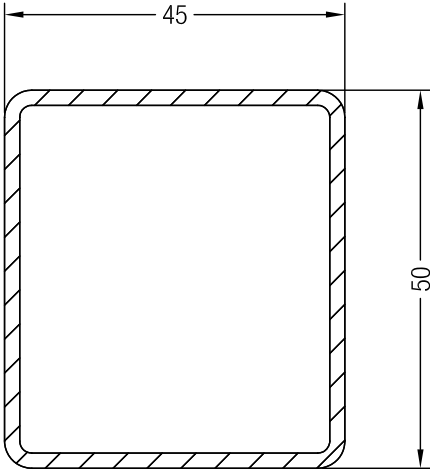
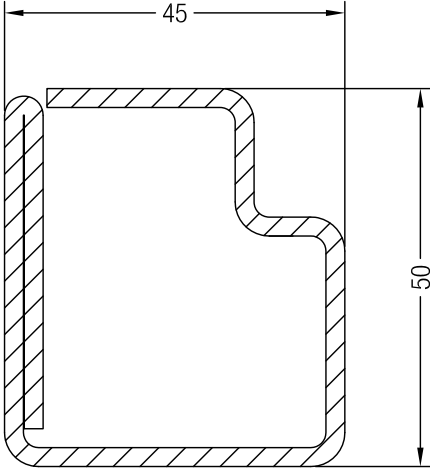
	Art.-Nr.		lx	ly
	1357542	1,5	1,5	3,2
	1357545	2	11,1	13,1
	1357553	4	19,3	22,8
	1357546	2,5	14,1	15,4

Armierungen

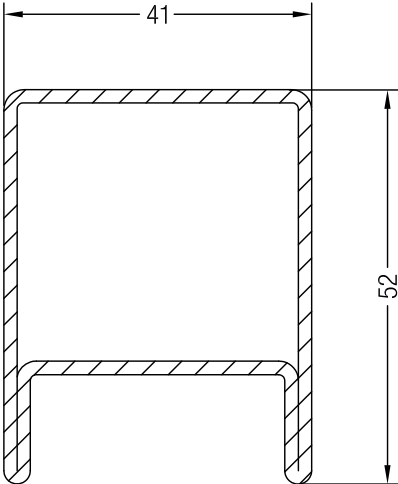
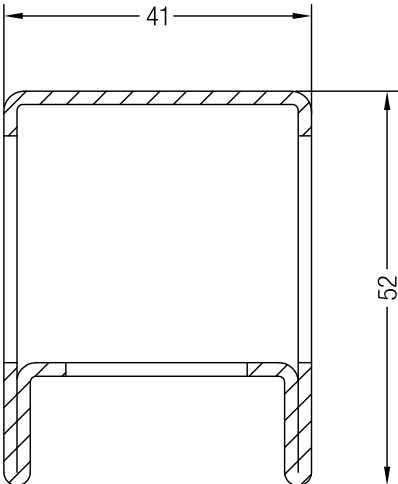
	Art.-Nr.		lx	ly
	1357597	1,75	9,7	10,5
	1357598	1,75	vorkonfektioniert für Schloss	

Armierungen

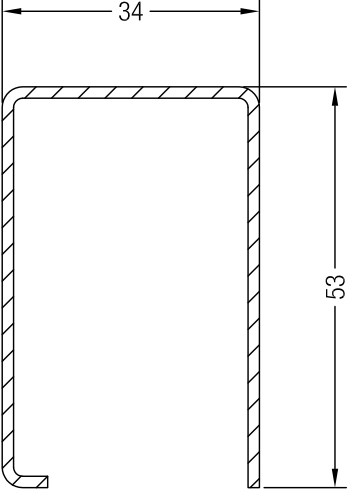
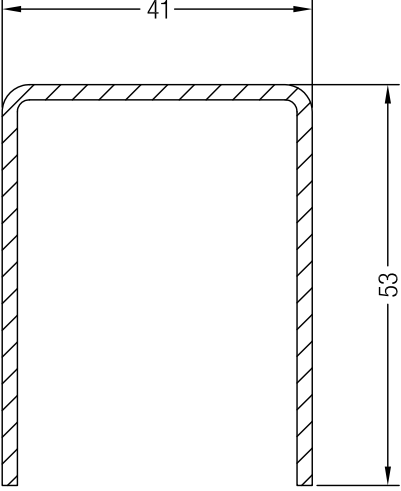
	Art.-Nr.		lx	ly
	1357547	1,5	4,6	6,5
	1357548	2	8,7	8,4

Armierungen

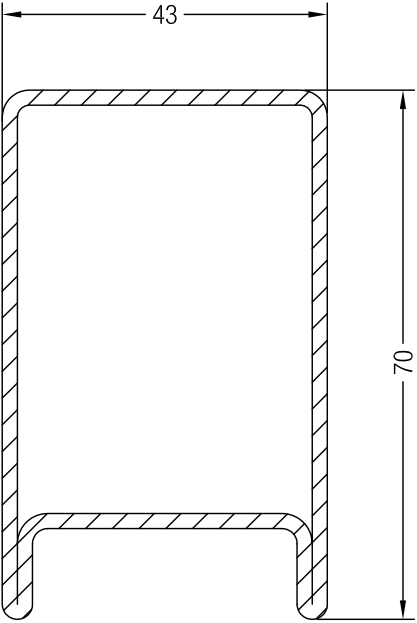
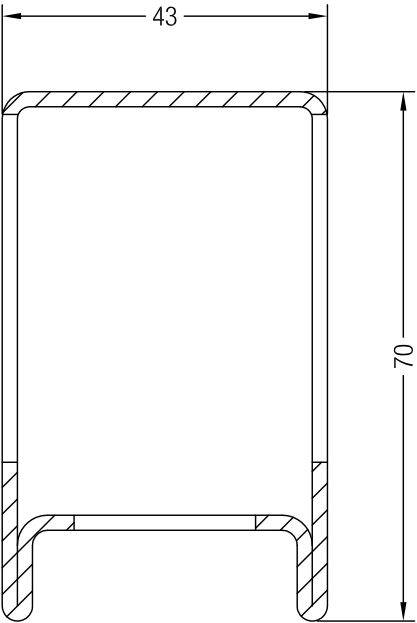
	Art.-Nr.		lx	ly
	1357549	2	14,9	27,1
	1357556	2	vorkonfektioniert für Schloss	

Artikelverzeichnis

Art.-Nr.	Bezeichnung	Pack/ Bündel in m	Langgutpalette in m		Karton/ Beutel in Stück	Seite
			Pack	Schrumpf		
1207679	Schraube 4,2 x 120				100	35
1211728	Anschlagdichtung Schwarz	400				39
1211738	Anschlagdichtung Silbergrau	400				39
1237091	Armierung 35 x 28	6/300				56
1239583	Armierung 35 x 20 x 1,5	6/504				46
1244506	Armierung 35 x 28 x 1,5	6/504				48
1244516	Armierung 35 x 28 x 1,5	6/432				48
1244526	Armierung 35 x 28 x 2	6/432				48
1244536	Armierung 35 x 28 x 2	6/312				48
1247725	Schraube 4,2 x 100				200	35
1247898	Armierung 40 x 10 x 2	6/378				45
1248095	Bürstendichtung 6,7 x 9				50	40
1260448	Mechanischer Verbinder universal (für Ausgleichsprofil 48)	2				35
1261801	Armierung 35 x 10 x 2	6/480				45
1261831	Armierung 35 x 20 x 1,5	6/300				45
1261841	Armierung 35 x 20 x 2	6/300				45
1306617	Armierung 30 x 28 x 2	6/290				48
1306619	Armierung 23 x 28 x 1,5	6/504				47
1313130	Armierung 28 x 28 x 2	6/396				47
1320701	Armierung HT-Falz 50 x 4 x 2, konfektioniert	1,9				45
1351875	Armierung 35 x 19 x 2,5	6/378				45
1351893	Armierung 35 x 20 x 2	6/324				46
1352512	Armierung 41 x 28 x 2	6/288				49
1352515	Armierung 41,8 x 28 x 2	6/384				49
1353383	Kältestopp	6				41
1353550	Deckleiste Flügel T SYNEGO®	6				41
1353616	Spannhebel	1				42
1356663	Set Bodenschwelle Bautiefe 80	6				36
1356673	Deckelprofil auswärts öffnend Bautiefe 80	6				36
1357341	Wetterschenkel SYNEGO®	6				40
1357344	Ausgleichsprofil SYNEGO®	6				39
1357451	Anschlag- Verglasungsdichtung AVSS	200				5
1357540	Armierung 23 x 28 x 1,5	6/504				47
1357541	Armierung 23 x 38 x 1,5	6/468				51
1357542	Armierung 23 x 38 x 1,5	6/480				52
1357543	G-Armierung 35 x 36 x 2	6/240				51
1357544	Armierung 35 x 30 x 2	6/300				50
1357545	Armierung 45 x 50 x 2	6/192				52
1357546	G-Armierung 45 x 50 x 2,5	6/126				52
1357547	Armierung 34 x 53 x 1,5	6/324				54
1357548	Armierung 41 x 53 x 2	6/276				54

Artikelverzeichnis

Art.-Nr.	Bezeichnung	Pack/ Bündel in m	Langgutpalette in m		Karton/ Beutel in Stück	Seite
			Pack	Schrumpf		
1357549	Armierung 43 x 70 x 2	6/150				55
1357550	Armierung 29 x 28 x 2	6/360				47
1357551	Armierung 35 x 30 x 2,5	6/216				50
1357552	Armierung 40 x 25 x 2	6/312				46
1357553	Armierung 45 x 50 x 4	6/96				52
1357554	Armierung 42,8 x 28 x 2	6/336				49
1357556	Armierung 43 x 70 x 2, konfektioniert	2,4				55
1357559	Armierung 29 x 37,5 x 2	6/270				51
1357590	Armierung 41 x 20 x 2	6/288				46
1357597	Armierung 41 x 52 x 1,75	6/192				53
1357598	Armierung 41 x 52 x 1,75, konfektioniert	2,2				53
1357608	Armierung 35 x 36 x 2	6/216				50
1357610	Armierung 28 x 28 x 1,5	6/396				47
1357666	Armierung 35 x 30 x 1,5	6/336				50
1358024	Endkappe Stulpprofil außen SYNEGO®				50	26
1358026	Endkappe Stulpprofil innen SYNEGO® (rechts)				50	26
1358027	Endkappe Stulpprofil innen SYNEGO® (links)				50	26
1358028	Endkappe Stulpflügel SYNEGO® (rechts)				50	29
1358029	Endkappe Stulpflügel SYNEGO® (links)				50	29
1358033	Mechanischer Verbinder universal Pfosten 96 SYNEGO®	2				34
1358034	Endkappe Blindpfosten außen SYNEGO®				50	27
1358036	Endkappe Blindpfosten innen SYNEGO® (rechts)				50	27
1358037	Endkappe Blindpfosten innen SYNEGO® (links)				50	27
1358038	Endkappe Stulpbleiste innen SYNEGO® (rechts)				50	30
1358039	Endkappe Stulpbleiste innen SYNEGO® (links)				50	30
1358042	Dichtblock Pfosten 96 MD SYNEGO®				50	32
1358043	Dichtblock Pfosten 124 MD SYNEGO®				50	32
1358044	Mechanischer Verbinder Sprosse 68 SYNEGO®				50	34
1358045	Montageplatte Pfosten 96 und 124 SYNEGO®				400	35
1358046	Mechanischer Verbinder Pfosten 96 AD SYNEGO®				50	31
1358047	Mechanischer Verbinder Pfosten 124 AD SYNEGO®				50	31
1358048	Set Pfostenwinkel SYNEGO®				20	34
1358052	Endkappe Wetterschenkel SYNEGO® (rechts)				50	40
1358053	Endkappe Wetterschenkel SYNEGO® (links)				50	40
1358054	Endkappe Wetterschenkel Stulp SYNEGO® (rechts)				50	40
1358055	Endkappe Wetterschenkel Stulp SYNEGO® (links)				50	40
1358056	Endkappe Ausgleichsprofil SYNEGO® (rechts)				50	39
1358057	Endkappe Ausgleichsprofil SYNEGO® (links)				50	39
1358058	Dichtteil Pfosten 96 MD SYNEGO®				50	33
1358059	Bohrlehre mech. Verbinder Sprossen SYNEGO®				1	44
1358061	Bohrlehre mech. Verbinder Pfosten/Sprosse AD SYNEGO®				1	43

Artikelverzeichnis

Art.-Nr.	Bezeichnung	Pack/ Bündel in m	Langgutpalette in m		Karton/ Beutel in Stück	Seite
			Pack	Schrumpf		
1358062	Bohrlehre mech. Verbinder Pfosten/Sprosse MD SYNEGO®				1	43
1358063	Bohrlehre mech. Verbinder Pfostenwinkel SYNEGO®				1	43
1358064	Bohrlehre Elementkopplung SYNEGO®				1	43
1358065	Bohrlehre Schwellenhalter SYNEGO®				1	43
1358066	Mechanischer Verbinder Sprosse 96 SYNEGO®				50	34
1358100	Schwellenhalter Blendrahmen 72 SYNEGO® (rechts)				50	37
1358101	Schwellenhalter Blendrahmen 72 SYNEGO® (links)				50	37
1358102	Schwellenhalter Blendrahmen 82 SYNEGO® (rechts)				50	37
1358103	Schwellenhalter Blendrahmen 82 SYNEGO® (links)				50	37
1358104	Schwellenhalter Pfosten 96 SYNEGO®				50	38
1358105	Schwellenhalter Pfosten 124 SYNEGO®				50	38
1358106	Schwellenhalter Blendrahmen 103 SYNEGO® (rechts)				50	37
1358107	Schwellenhalter Blendrahmen 103 SYNEGO® (links)				50	37
1358108	Set Windstopp AD SYNEGO®				50	39
1358109	Set Windstopp MD SYNEGO®				50	39
1358110	Endkappe Stulpleiste außen SYNEGO®				50	30
1358113	Schweißbarer Eckverbinder HT-Flügel SYNEGO®				96	42
1358114	Schweißbarer Eckverbinder Flügel 86/106 SYNEGO®				96	42
1358115	Mechanischer Verbinder Pfosten 96 AD SYNEGO®				50	31
1358116	Mechanischer Verbinder Pfosten 124 AD SYNEGO®				50	31
1358118	Mechanischer Verbinder Pfosten 96 MD SYNEGO®				50	33
1358119	Mechanischer Verbinder Pfosten 96 MD SYNEGO® Kreuzverbindung				50	33
1358122	Mechanischer Verbinder Pfosten 96 AD SYNEGO®				50	32
1358128	Mechanischer Verbinder Pfosten 124 MD SYNEGO®				50	33
1358129	Bohrlehre mech. Verbinder Pfosten 96/124 MD SYNEGO®				1	43
1358663	Set Bodenschwelle 127 SYNEGO®				6	36
1537145	Altbaublendrahmen 57/60 MD SYNEGO®	24	432			9
1537195	Blendrahmen 72/40 MD PULS SYNEGO®	24	360	336		10
1537205	Flügel Z51 SYNEGO®	24	432	504		16
1537245	Flügel 59 rund SYNEGO®	24	360	360		19
1537285	Klebflügel Z53 PULS SYNEGO®	24	360	462		17
1537295	Haustürflügel Z SYNEGO®	13	273	273		22
1537305	Haustürflügel T SYNEGO®	13	273	273		23
1537325	Ausgleichsprofil 95 SYNEGO®	12	252			15
1537335	Ausgleichsprofil 48 SYNEGO®	24	360			14
1537340	Falzeinlageprofil SYNEGO®	72				41
1537405	Pfosten 96 AD PULS SYNEGO®	24	288	378		4
1537408	Pfosten 96 AD PULS SYNEGO® für Alu-Vorsatzschale	24	288			4
1537415	Pfosten 124 AD SYNEGO®	12	252	252		5
1537425	Sprosse 68 SYNEGO®	36	432	588		24
1537435	Sprosse 96 SYNEGO®	24	288			25







Artikelverzeichnis

Art.-Nr.	Bezeichnung	Pack/ Bündel in m	Langgutpalette in m		Karton/ Beutel in Stück	Seite
			Pack	Schrumpf		
1537440	Stulpprofil SYNEGO® (ohne Universal- und Stulpdichtung)	24	600			26
1537445	Stulpprofil SYNEGO®	24	480			26
1537455	Blindpfosten SYNEGO®	24	360			27
1537475	Stulpflügel Z51 SYNEGO®	24	576			28
1537485	Stulpflügel Z59 SYNEGO®	24	432			29
1537495	Stulpleiste SYNEGO®	36	1404			30
1537505	Pfosten 96 MD PULS SYNEGO®	24	288	378		12
1537508	Pfosten 96 MD PULS SYNEGO® für Alu-Vorsatzschale	24	288			12
1537515	Pfosten 124 MD SYNEGO®	12	252	252		13
1537525	Flügel Z59 PULS SYNEGO®	24	360	420		18
1537535	Flügel Z86 SYNEGO®	24	216	294		20
1537545	Flügel T106 SYNEGO®	12	216	252		21
1537605	Blendrahmen 72 AD PULS SYNEGO®	24	360	462		2
1537608	Blendrahmen 72 AD PULS SYNEGO® für Alu-Vorsatzschale	24	360			2
1537615	Blendrahmen 82 AD PULS SYNEGO®	24	288	378		3
1537618	Blendrahmen 82 AD PULS SYNEGO® für Alu-Vorsatzschale	24	288			3
1537625	Blendrahmen 72 MD PULS SYNEGO®	24	360	462		6
1537628	Blendrahmen 72 MD PULS SYNEGO® für Alu-Vorsatzschale	24	360			6
1537635	Blendrahmen 82 MD PULS SYNEGO®	24	288	378		7
1537638	Blendrahmen 82 MD PULS SYNEGO® für Alu-Vorsatzschale	24	288			7
1537645	Blendrahmen 103 MD PULS SYNEGO®	12	216	216		8
1537648@	Blendrahmen 103 MD PULS SYNEGO® für Alu-Vorsatzschale	12	252			8
1537655@	Blendrahmen 100 MD SYNEGO®	12	252	294		11
1537658@	Blendrahmen 100 MD SYNEGO® für Alu-Vorsatzschale	12	216	294		11
1537665	Altbaublendrahmen 57/60 MD SYNEGO®	24	432			9
1567145@	Altbaublendrahmen 57/60 MD SYNEGO® (kaschiert)	24	432			9
1567195@	Blendrahmen 72/40 MD PULS SYNEGO® (kaschiert)	24	360			10
1567205	Flügel Z51 SYNEGO® (kaschiert)	24	432			16
1567245	Flügel 59 rund SYNEGO® (kaschiert)	24	360			19
1567285	Klebeflügel Z53 PULS SYNEGO® (kaschiert)	24	360			17
1567295	Haustürflügel Z SYNEGO® (kaschiert)	13	273			22
1567305	Haustürflügel T SYNEGO® (kaschiert)	13	273			23
1567325@	Ausgleichsprofil 95 SYNEGO® (kaschiert)	12	216			15
1567335@	Ausgleichsprofil 48 SYNEGO® (kaschiert)	24	360			14
1567405	Pfosten 96 AD PULS SYNEGO® (kaschiert)	24	288			4
1567415	Pfosten 124 AD SYNEGO® (kaschiert)	12	252			5
1567425	Sprosse 68 SYNEGO® (kaschiert)	36	432			24
1567435	Sprosse 96 SYNEGO® (kaschiert)	24	288			25
1567445	Stulpprofil SYNEGO® (kaschiert)	24	480			26
1567455	Blindpfosten SYNEGO® (kaschiert)	24	360			27
1567475	Stulpflügel Z51 SYNEGO® (kaschiert)	24	576			28

Artikelverzeichnis

Art.-Nr.	Bezeichnung	Pack/ Bündel in m	Langgutpalette in m		Karton/ Beutel in Stück	Seite
			Pack	Schrumpf		
1567485	Stulpflügel Z59 SYNEGO® (kaschiert)	24	504			29
1567495	Stulpleiste SYNEGO® (kaschiert)	36	1404			30
1567505	Pfosten 96 MD PULS SYNEGO® (kaschiert)	24	288			12
1567515	Pfosten 124 MD SYNEGO® (kaschiert)	12	252			13
1567525	Flügel Z59 PULS SYNEGO® (kaschiert)	24	360			18
1567535	Flügel Z86 SYNEGO® (kaschiert)	24	252			20
1567545	Flügel T106 SYNEGO® (kaschiert)	12	216			21
1567605	Blendrahmen 72 AD PULS SYNEGO® (kaschiert)	24	360			2
1567615	Blendrahmen 82 AD PULS SYNEGO® (kaschiert)	24	288			3
1567625	Blendrahmen 72 MD PULS SYNEGO® (kaschiert)	24	360			6
1567635	Blendrahmen 82 MD PULS SYNEGO® (kaschiert)	24	288			7
1567645	Blendrahmen 103 MD PULS SYNEGO® (kaschiert)	12	216			8
1567655@	Blendrahmen 100 MD SYNEGO® (kaschiert)	12	216			11
1567665@	Altbaublendrahmen 57/60 MD SYNEGO® (kaschiert)	24	432			9

Zeichenerklärung

	Farbe Schwarz
	Farbe Grau
	Farbe Weiß
	Farbe Cremeweiß
	Farbe Braun
	Farbe Karamell
	Farbe Grün
	Farbe Rot
	Farbe Silber
	Farbe beliebig
	Aluminium natur eloxiert
	Aluminium pressblank
	Kaschierte Ausführung
	Lackierte Ausführung
	Verpackungseinheit (Details siehe Artikelverzeichnis)
	Wanddicke in mm
	Mit verschweißbarer Dichtung
	Mit nicht verschweißbarer Dichtung
	Manuell einzuziehende Dichtung
	Rechte Ausführung
	Linke Ausführung
@	Außerstandard, Lieferzeit auf Anfrage
I_x	Trägheitsmoment in X-Richtung in cm^4 bezogen auf E-Modul von Stahl
I_y	Trägheitsmoment in Y-Richtung in cm^4 bezogen auf E-Modul von Stahl
	Mit PVC-Kleber verkleben, weiße Profile mit Kleber 1251660/1251670, kaschierte Profile mit lösemittelfreien Klebstoff (z.B. Cosmofen 515, Fa. Weiss).
	Mit Silikon abdichten
	Mit EPDM-Dichtmasse abdichten
	Mit EPDM-Kleber verkleben
	Linsenkopf-Blechschaube ISO 7049
	Senkkopf-Blechschaube ISO 7050
	Senkkopf-Bohrschraube ISO 15482
	Linsenkopf-Bohrschraube ISO 15481
	Bohr- und Schneidlehre
	Fräsbild
E	Alu-Vorsatzschale

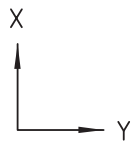

Variantsystematik

Weiße Profile:

Nach der Artikelnummer (z.B. 1537005) folgt eine 4-stellige Variante (z.B. 1701), die bei Haupt- und Zusatzprofilen gleichermaßen aufgebaut ist.



Die Variante besteht aus jeweils 4 Stellen:



- 1. und 2. Stelle: Verpackungsart
- 3. und 4. Stelle: Farbnummer

1. und 2. Stelle	Verpackungsart
17	Schlauch-Langgutpalette (LGP)
19	Schrumpf-Langgutpalette (LGP)

3. und 4. Stelle	Farbnummer	
	Profil	Profil/Dichtung
01	Weiß 159	Weiß/Schwarz 159/601
05	Weiß 159	Weiß/Weiß 159/159
15	-	Weiß/Grau 159/RAL 7001

Beispiele:

XXXXXXX  - Artikel in Weiß ohne Dichtung
 36
 kleinste Verpackungseinheit 36 m
 Variante 1701: Schlauch-LGP
 Variante 1901: Schrumpf-LGP

XXXXXXX   - Artikel in Weiß mit weißer Dichtung
 24
 kleinste Verpackungseinheit 24 m
 Variante 1705: Schlauch-LGP
 Variante 1905: Schrumpf-LGP





XXXXXXX   - Artikel in Weiß mit grauer Dichtung
 36
 kleinste Verpackungseinheit 36 m
 Variante 1715: Schlauch-LGP
 Variante 1915: Schrumpf-LGP

 Achtung: Nicht alle Profile werden in allen oben gelisteten Varianten angeboten.

Kaschierte Profile:

Für kaschierte Profile ist abhängig von der gewünschten Farbkombination eine 4-stellige Farbvariante aus dem Standardfarbtableau zu entnehmen. Kaschierte Profile werden generell in der Verpackungsart Schlauch-Langgutpalette geliefert.

Beispiele:

XXXXXXX    - Artikel kaschiert mit schwarzer Dichtung
 24
 kleinste Verpackungseinheit 24 m
 Verpackung generell in Schlauch-LGP
 Farbvariante nach Standardfarbtableau

Materialnummer

Die 7-stellige Artikelnummer (z.B. 1537005) wird mit der 4-stelligen Variante (z.B. 1701) zu einer 11-stelligen Materialnummer zusammengefasst (z.B. 15370051701).

Die Unterlage ist urheberrechtlich geschützt. Die dadurch begründeten Rechte, insbesondere die der Übersetzung, des Nachdruckes, der Entnahme von Abbildungen, der Funksendungen, der Wiedergabe auf fotomechanischem oder ähnlichem Wege und der Speicherung in Datenverarbeitungsanlagen, bleiben vorbehalten.

Unsere anwendungsbezogene Beratung in Wort und Schrift beruht auf langjährigen Erfahrungen sowie standardisierten Annahmen und erfolgt nach bestem Wissen. Der Einsatzzweck der REHAU Produkte ist abschließend in den technischen Produktinformationen beschrieben. Die jeweils gültige Fassung ist online unter www.rehau.com/TI einsehbar. Anwendung, Verwendung und Verarbeitung der Produkte erfolgen außerhalb unserer Kontrollmöglichkeiten und liegen daher ausschließlich im Verantwortungsbereich des jeweiligen Anwenders/Verwenders/Verarbeiters. Sollte dennoch eine Haftung in Frage kommen, richtet sich diese ausschließlich nach unseren Lieferungs- und Zahlungsbedingungen, einsehbar unter www.rehau.com/conditions, soweit nicht mit REHAU schriftlich etwas anderes vereinbart wurde. Dies gilt auch für etwaige Gewährleistungsansprüche, wobei sich die Gewährleistung auf die gleichbleibende Qualität unserer Produkte entsprechend unserer Spezifikation bezieht. Technische Änderungen vorbehalten.